



**HAVELLS**

*Powering Lives...*

Pricelist w.e.f. 1<sup>st</sup> April, 2026

# LV SWITCHGEAR, CONTROLGEAR & POWER QUALITY SOLUTIONS





## CONTENTS

### Powergear

Titania Air Circuit Breaker _____	10
QTRON Moulded Case Circuit Breaker _____	18
ATRON Moulded Case Circuit Breaker _____	22
Loadline Moulded Case Circuit Breaker _____	25
High Voltage AC & DC - Circuit Breakers _____	32
Hi Pann _____	35
PowerSafe Load Bank MCCB Panel Boards _____	37
Busbar Chamber _____	38
InstaShift Manual Changeover Switch _____	39
InstaShift Motorised Changeover Switch _____	39
InstaShift Automatic Changeover Switch _____	40
Instaprime / Instaline Automatic Transfer Switch _____	42
Euroload Changeover Switch _____	43
Euroload By-Pass Changeover Switch _____	43
Euroload Switch Disconnecter _____	44
Kompact Switch Disconnecter Fuse _____	45
Hibreak Fuse Base _____	48
HBC Fuse Link _____	49

### Controlgear

3 Pole Power Contactors _____	54
4 Pole, 2 Pole Power Contactors & Control Relay _____	55
3 Pole HGS R Contactors _____	56
Accessories - HGS Series Contactors _____	58
Thermal Overload Relay - HGST _____	59
Capacitor Duty Contactors _____	60
Electronic Motor Protection Relay _____	53
MPCB & Accessories - HGSM _____	63
MPCB & Accessories - HGSTM / HGSMR _____	64
Industrial Motor Starter, Submersible Motor Starter & Spares - HGS _____	68
Agricultural Motor Starter - Urjalite DOL Starter, Urja DOL Starter _____	73
Urja DOL Submersible & ASD Submersible Starter _____	74
Urja Kavach - Single Phase Submersible Controller (STD & DLX) _____	75
Urja Contactor 4 P & 2 P, Thermal Overload Relay 3 P & 2 P _____	76
Spares & Accessories - Urja _____	77
Street Light Panel _____	80

### Power Quality Solutions

Single Phase Capacitors _____	84
Cylindrical Capacitors (MPP Type) _____	84
Box Capacitors (MPP Type) _____	86
HD Harmonic Detuned Reactors _____	90
IPFC Relay _____	91
Thyristor Switch _____	91
Capacitor Duty Contactor _____	92
APFC Panel _____	95
Active Harmonic Filter _____	96
Agri Boost Capacitors _____	99

# ABOUT US

## Redefining the modern homes with innovation and excellence

Havells is at the forefront of transforming modern living spaces by offering innovative solutions that elevate everyday experiences. With a deep understanding of consumer needs, the company has expanded its footprint across every aspect of home life, creating environment that are not only functional but also comfortable, stylish, and future-ready. To make these solutions accessible, Havells leverages an extensive distribution network encompassing 18,000 dealers, over 1,000 exclusive brand stores, intensifying presence in modern retail, e-commerce and quick commerce.

The company's portfolio includes power brands like Havells, Havells Crabtree, Lloyd, REO, Havells Studio, and Standard each designed to cater to the unique demands of today's consumers.

Anchored in the 'Make in India' initiative, Havells operates 16 cutting-edge manufacturing facilities across India, producing 90% of its products in-house. At the forefront of Havells product evolution lies its Customer Experience & Designs (CXD) Studio, where creativity and user-centric design converge. This is complemented by its Centre for Research & Innovation (CRI), supported by four advanced R&D centres, enabling Havells to consistently deliver products that are both functional and visually compelling.

Driven by a commitment to innovation, quality, and design, the company also upholds sustainable practices throughout its operations, including eco-friendly manufacturing processes and energy-efficient product design, contributing to a greener and more sustainable future.



CORPORATE OFFICE, NOIDA



State-of-the-Art Manufacturing Unit



Industry 4.0 Process



Center For Research & Innovation



Customer Experience & Design



**16** Manufacturing Units

**~18000** Strong Dealer Network

**4** Research Centres

**48** Offices

# DRIVEN BY INNOVATION. POWERED BY INDIA.



Innovation



Technology



Digitalization





# ACB Ordering Code Logic

1, 2, 3	4	5	6	7	8, 9	10		11, 12		13
Product	Pole	Breaking Capacity	Mounting Type	IPR	Rating	Closing Coil & Charging Motor		SHT & UVT		Current Transformer
						CC (Voltage)	CM (Voltage)	UVT (Voltage)	SHT (Voltage)	
IHA	T	E	Manual Fixed = 1	Bus Coupler = 0	400 A = 04	24 V	220 = A	415 V	24 V = 01	If rating same as ACB rating then = 0
	TP	50 kA	Manual Drawout = 2	IPR 1 = 1	630 A = 06	110 V	220 = B	415 V	110 V = 02	400 A = A
	F	S	Electrical Fixed = 4	IPR 3 = 3	800 A = 08	220 V	220 = C	415 V	220 V = 03	630 A = B
	FP	65 kA	Electrical Drawout = 5	IPR 5 = 5	1000 A = 10	415 V	220 = D	415 V	415 V = 04	800 A = C
		H		IPR E = E	1250 A = 12	24 V	110 = E	415 V	0 = 05	1000 A = D
		75 kA			1600 A = 16	110 V	110 = F	220 V	24 V = 06	1250 A = E
					2000 A = 20	220 V	110 = G	220 V	110 V = 07	1600 A = F
					2500 A = 25	415 V	110 = H	220 V	220 V = 08	2000 A = G
						Not req.	Not req. = 0	220 V	415 V = 09	2500 A = H
								220 V	0 = 10	3200 A = I
								110 V	24 V = 11	4000 A = J
								110 V	110 V = 12	5000 A = K
								110 V	220 V = 13	6300 A = L
								110 V	415 V = 14	
								110 V	0 = 15	
								24 V	24 V = 16	
								24 V	110 V = 17	
								24 V	220 V = 18	
								24 V	415 V = 19	
								24 V	0 = 20	
									24 V = 21	
									110 V = 22	
									220 V = 23	
									415 V = 24	

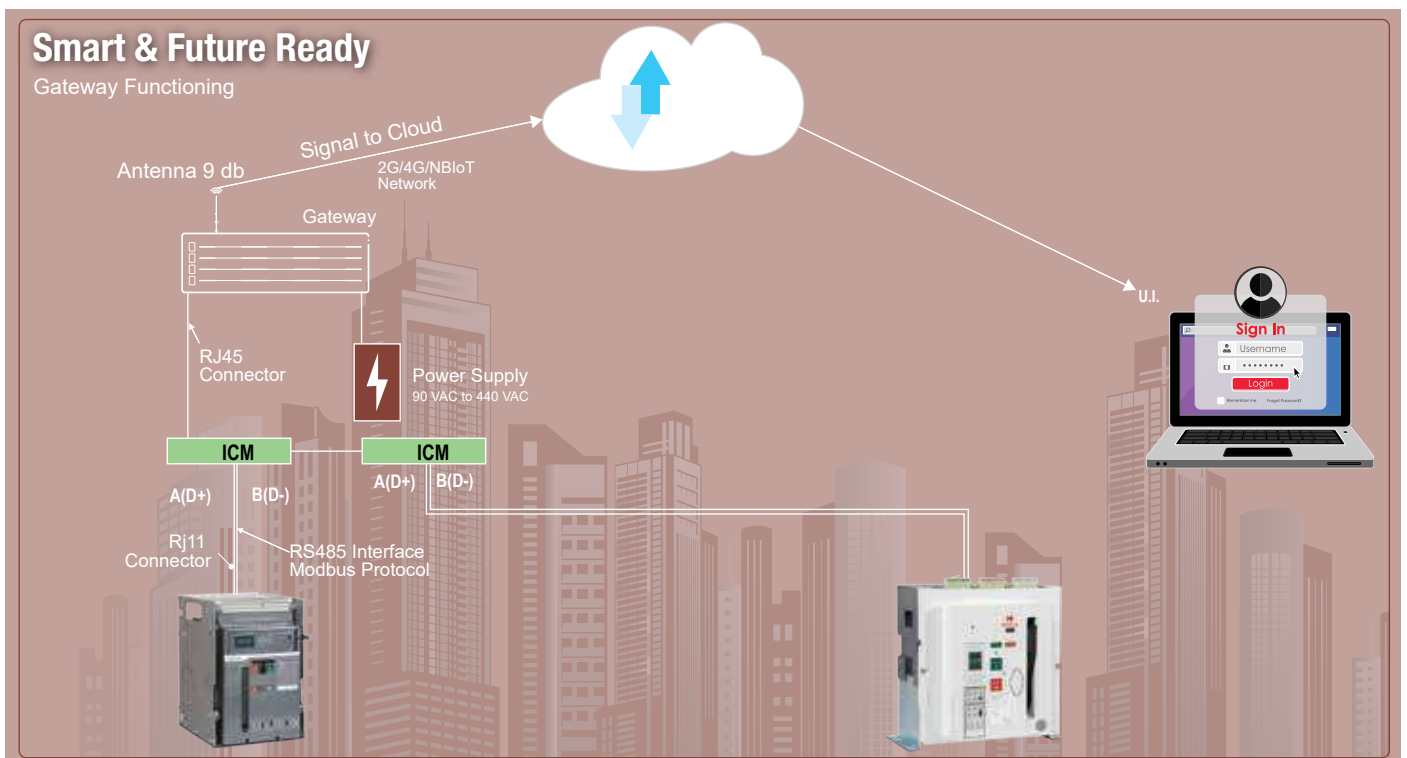



# Titania

Air Circuit Breaker

400 A – 3200 A

Breaking Capacity @ 415 V	E Frame	S Frame	H Frame
	<b>400 A - 2000 A</b>	<b>400 A - 2000 A</b>	<b>2500 A - 3200 A</b>
lcs=100% lcu	50 kA	65 kA	65 kA
lcw for 1 s	50 kA	50 kA	65 kA



# Titania+

Air Circuit Breaker

630 A – 6300 A

Breaking Capacity @ 415 V	A Frame	AA Frame	B Frame	C Frame	D Frame
	<b>630 A - 1600 A</b>	<b>2000 A - 2500 A</b>	<b>3200 A - 4000 A</b>	<b>5000 A</b>	<b>6300 A</b>
lcs=100% lcu	65 kA	85 kA	100 kA	100 kA	150 kA
lcw for 1 s	50 kA	70 kA	85 kA	85 kA	100 kA

# Titania Air Circuit Breaker

(Conforms to IS/IEC:60947-2)



## 3 Pole ACB with Microprocessor Release IPR 1+

Current Rating	Rated Ultimate Short-circuit Breaking Capacity Ics = 100 % Icu at	MANUAL				ELECTRICAL*	
		Item Code	Per Unit LP (₹)	Item Code	Per Unit LP (₹)	Item Code	
(A)	415 V (kA)	Fixed		Drawout		Fixed	Drawout
630 A	50 kA	IHATE11060**#	196275.00	IHATE21060**#	255150.00	IHATE4106\$**#	IHATE5106\$**#
800 A	50 kA	IHATE11080**#	196275.00	IHATE21080**#	255150.00	IHATE4108\$**#	IHATE5108\$**#
1000 A	50 kA	IHATE11100**#	200075.00	IHATE21100**#	264600.00	IHATE4110\$**#	IHATE5110\$**#
1250 A	50 kA	IHATE11120**#	223475.00	IHATE21120**#	286250.00	IHATE4112\$**#	IHATE5112\$**#
1600 A	50 kA	IHATE11160**#	243725.00	IHATE21160**#	311525.00	IHATE4116\$**#	IHATE5116\$**#
2000 A	50 kA	IHATE11200**#	281400.00	IHATE21200**#	375925.00	IHATE4120\$**#	IHATE5120\$**#

## 3 Pole ACB with Microprocessor Release IPR 1+

Current Rating	Rated Ultimate Short-circuit Breaking Capacity Ics = 100 % Icu at	MANUAL				ELECTRICAL*	
		Item Code	Per Unit LP (₹)	Item Code	Per Unit LP (₹)	Item Code	
(A)	415 V (kA)	Fixed		Drawout		Fixed	Drawout
630 A	65 kA	IHATS11060**#	213650.00	IHATS21060**#	328925.00	IHATS4106\$**#	IHATS5106\$**#
800 A	65 kA	IHATS11080**#	213650.00	IHATS21080**#	328925.00	IHATS4108\$**#	IHATS5108\$**#
1000 A	65 kA	IHATS11100**#	223575.00	IHATS21100**#	361600.00	IHATS4110\$**#	IHATS5110\$**#
1250 A	65 kA	IHATS11120**#	276725.00	IHATS21120**#	408150.00	IHATS4112\$**#	IHATS5112\$**#
1600 A	65 kA	IHATS11160**#	292850.00	IHATS21160**#	443900.00	IHATS4116\$**#	IHATS5116\$**#
2000 A	65 kA	IHATS11200**#	314525.00	IHATS21200**#	471475.00	IHATS4120\$**#	IHATS5120\$**#
2500 A	65 kA	IHATN11250**#	364850.00	IHATN21250**#	553000.00	IHATN4125\$**#	IHATN5125\$**#
3200 A	65 kA	IHATN11320**#	456900.00	IHATN21320**#	604275.00	IHATN4132\$**#	IHATN5132\$**#

## 4 Pole ACB with Microprocessor Release IPR 1+

Current Rating	Rated Ultimate Short-circuit Breaking Capacity Ics = 100 % Icu at	MANUAL				ELECTRICAL*	
		Item Code	Per Unit LP (₹)	Item Code	Per Unit LP (₹)	Item Code	
(A)	415 V (kA)	Fixed		Drawout		Fixed	Drawout
630 A	50 kA	IHAPE11060**#	235625.00	IHAPE21060**#	315625.00	IHAPE4106\$**#	IHAPE5106\$**#
800 A	50 kA	IHAPE11080**#	235625.00	IHAPE21080**#	315625.00	IHAPE4108\$**#	IHAPE5108\$**#
1000 A	50 kA	IHAPE11100**#	246100.00	IHAPE21100**#	337375.00	IHAPE4110\$**#	IHAPE5110\$**#
1250 A	50 kA	IHAPE11120**#	265025.00	IHAPE21120**#	363000.00	IHAPE4112\$**#	IHAPE5112\$**#
1600 A	50 kA	IHAPE11160**#	299075.00	IHAPE21160**#	398775.00	IHAPE4116\$**#	IHAPE5116\$**#
2000 A	50 kA	IHAPE11200**#	353975.00	IHAPE21200**#	474850.00	IHAPE4120\$**#	IHAPE5120\$**#

\* Please refer table A to Product price list  
 To replace \$ Please refer table 1 at page-12  
 To replace \*\* Please refer table 2 at page-12  
 To replace # Please refer table 3 at page-12  
 Door Flange (Escutcheon Frame) is supplied alongwith ACB

# Titania Air Circuit Breaker

(Conforms to IS/IEC:60947-2)

## 4 Pole ACB with Microprocessor Release IPR 1+

Current Rating	Rated Ultimate Short-circuit Breaking Capacity Ics = 100 % Icu at	MANUAL				ELECTRICAL*	
		Item Code	Per Unit LP (₹)	Item Code	Per Unit LP (₹)	Item Code	
(A)	415 V (kA)	Fixed		Drawout		Fixed	Drawout
630 A	65 kA	IHAFS11060**#	255275.00	IHAFS21060**#	464725.00	IHAFS4106\$**#	IHAFS5106\$**#
800 A	65 kA	IHAFS11080**#	255275.00	IHAFS21080**#	464725.00	IHAFS4108\$**#	IHAFS5108\$**#
1000 A	65 kA	IHAFS11100**#	295500.00	IHAFS21100**#	476775.00	IHAFS4110\$**#	IHAFS5110\$**#
1250 A	65 kA	IHAFS11120**#	344650.00	IHAFS21120**#	555550.00	IHAFS4112\$**#	IHAFS5112\$**#
1600 A	65 kA	IHAFS11160**#	410700.00	IHAFS21160**#	650400.00	IHAFS4116\$**#	IHAFS5116\$**#
2000 A	65 kA	IHAFS11200**#	439225.00	IHAFS21200**#	663825.00	IHAFS4120\$**#	IHAFS5120\$**#
2500 A	65 kA	IHAFN11250**#	475900.00	IHAFN21250**#	661600.00	IHAFN4125\$**#	IHAFN5125\$**#
3200 A	65 kA	IHAFN11320**#	558025.00	IHAFN21320**#	725425.00	IHAFN4132\$**#	IHAFN5132\$**#

### Table - A

List prices Charges for product different version wrt IPR1+ ACB List Price		Per Unit LP (₹)
Bus Coupler w/o Protection	Reduce	28250.00
Micro processor release IPRE+ ( LI)	Reduce	12250.00
Micro processor release IPR3+ ( LSIG+ LCD Display+Thermal Memory+ Zone selectivity+ Current & Voltage Mesurment+ Advance protection +Over Tempeture Protection)	Add	40400.00
Micro processor release IPR5+( LCD Display+Thermal Memory+ Zone selectivity+ Advance protection+ Advance Mesurment Over Tempeture Protection+ Maximum Demand + Communication)	Add	56200.00
To Convert Electrical version from Manual version (includes Motor, Shunt trip & Closing Coil)	Add	63750.00

### 3. Communication Software

HSN Code: 85389000

SAP Code	Description	Per Unit LP (₹)
SACX0346	Communication software for IRP-5+	POR



Undervoltage release

### 4. Under Voltage Trip Device (UVT)

HSN Code: 85389000

SAP Code	Description	Per Unit LP (₹)
ISACX0196	220 V AC	6425.00
ISACX0197	415 V AC	6425.00

### 1. Spring Charging Motor

HSN Code: 85389000

SAP Code	Description	Per Unit LP (₹)
ISACX0358	Charging Motor 110 V	54450.00
ISACX0147	Charging Motor 230 V	54450.00

### 2. Shunt Trip / Closing Coil

HSN Code: 85389000

SAP Code	Description	Per Unit LP (₹)
ISACX0170	24 VDC	4650.00
ISACX0168	110 V AC/DC	4650.00
ISACX0167	220 V AC/DC	4650.00
ISACX0212	415 V AC	4650.00



Shunt Trip Coil / Closing Coil

\* Please refer table A to Product price list  
 To replace \$ Please refer table 1 at page-12  
 To replace \*\* Please refer table 2 at page-12  
 To replace # Please refer table 3 at page-12  
 Door Flange (Escutcheon Frame) is supplied alongwith ACB

# Titania Air Circuit Breaker

(Conforms to IS/IEC:60947-2)

## 5. Main CT's

HSN Code: 85389000

SAP Code	Description	Per Unit LP (₹)
ICELFACL018	CT 400 A	4420.00
ICELFACL001	CT 630 A	4420.00
ICELFACL002	CT 800 A	4420.00
ICELFACL003	CT 1000A	4655.00
ICELFACL004	CT 1250 A	4655.00
ICELFACL005	CT 1600 A	4655.00
ICELFACL006	CT 2000 A	6250.00
ICELFACL007	CT 2500A	6250.00

## 7. Key Lock / Key Interlock

HSN Code: 85389000

SAP Code	Description	Per Unit LP (₹)
ISACX0301	On/Off Button cover	590.00
ISACX0353	Key lock (1 lock+1 key)	2400.00
-	Key interlock (2 locks+1 keys)	3350.00
-	Key interlock (3 locks+2 keys)	7065.00
ISACX0341	Drawout position Lock	2910.00

## 9. Other Accessories

HSN Code: 85389000

SAP Code	Description	Per Unit LP (₹)
ISACX0208	Door Interlock	4265.00
ISACX0028	Close open cycle counter	4195.00

**Table 1**

Closing Coil & Charging Motor		
CC (Voltage)	CM (Voltage)	\$
24 V	220 V	A
110 V	220 V	B
220 V	220 V	C
415 V	220 V	D
24 V	110 V	E
110 V	110 V	F
220 V	110 V	G
415 V	110 V	H

**Table 2**

UVT & SHT		
UVT (Voltage)	SHT (Voltage)	**
415 V	24 V	01 (Zero one)
415 V	110 V	02
415 V	220 V	03
415 V	415 V	04
415 V	0	05
220 V	24 V	06
220 V	110 V	07
220 V	220 V	08
220 V	415 V	09
220 V	0	10
110 V	24 V	11
110 V	110 V	12
110 V	220 V	13
110 V	415 V	14
110 V	0	15
24 V	24 V	16
24 V	110 V	17
24 V	220 V	18
24 V	415 V	19
24 V	0	20
0	24 V	21
0	110 V	22
0	220 V	23
0	415 V	24
0	0	00 (Zero Zero)

## 6. Neutral CTs

HSN Code: 85389000

SAP Code	Description	Per Unit LP (₹)
ICELFACL019	NCT 400 A	4420.00
ICELFACL012	NCT 630 A	4420.00
ICELFACL013	NCT 800 A	4420.00
ICELFACL014	NCT 1000A	4655.00
ICELFACL015	NCT 1250 A	4655.00
ICELFACL016	NCT 1600 A	4655.00
ICELFACL017	NCT 2000 A	6250.00
ICELFACL021	NCT 2500A	6250.00

## 8. Adaptor Type Terminals (additional price)

HSN Code: 85389000

SAP Code	Description	Per Unit LP (₹)
ISSACX0174	630/800 A	6435.00
ISSACX0164	1000/1250 A	7065.00
ISSACP0434	1600 A	10000.00

(6 nos. reqd. for 3 pole & 8 nos. for 4 pole ACB)

## 10. Other Accessories

HSN Code: 85389000

SAP Code	Description	Per Unit LP (₹)
ISACX0207	Spring charge indication switch	2780.00
ISACX0349	Trip indication Switch	1755.00
ISACX0139	Aux. switch (5 c/o additional)	4275.00
ISACX0182	Position indication switch	3055.00
ISACX0302	Field test unit	4100.00

**Table 3**

Current Transformer	#
CT Rating is same as of ACB	0 (Zero)
400 A	A
630 A	B
800 A	C
1000A	D
1250 A	E
1600 A	F
2000 A	G

\*ACBs are supplied with following accessories as standard fitment:

Manual Fixed	Manual Drawout	Electrical Fixed	Electrical Drawout
Aux. Contact Unit 5CO	Aux. Contact Unit 5CO Safety Shutter Aux. Isolating contact unit Horizontal Terminals	Horizontal Terminals Shunt Trip Device Charging Motor Closing Coil	Aux. Contact Unit 5CO Safety Shutter Aux. Isolating contact unit Horizontal Terminals Shunt Trip Device Charging Motor Closing Coil

\*Additional accessories except standard fitment are available on extra price.

\*Neutral CT is supplied as a standard fitment in 4 Pole ACBs.

\*Neutral CT prices are to be added for 3 Pole ACBs for ground fault protection.

\*All orders should be accompanied with ACB order form included in catalogue.

\*1 This CT is required for GFT in 3 pole ACBs for 4 Pole ACBs main CTs is used as neutral CT.

\* Please refer table A to Product price list  
To replace \$ Please refer table 1 at page-12  
To replace \*\* Please refer table 2 at page-12  
To replace # Please refer table 3 at page-12  
Door Flange (Escutcheon Frame) is supplied alongwith ACB

# Titania Air Circuit Breaker

(Conforms to IS/IEC:60947-2)

## Intelligent Protection Releases

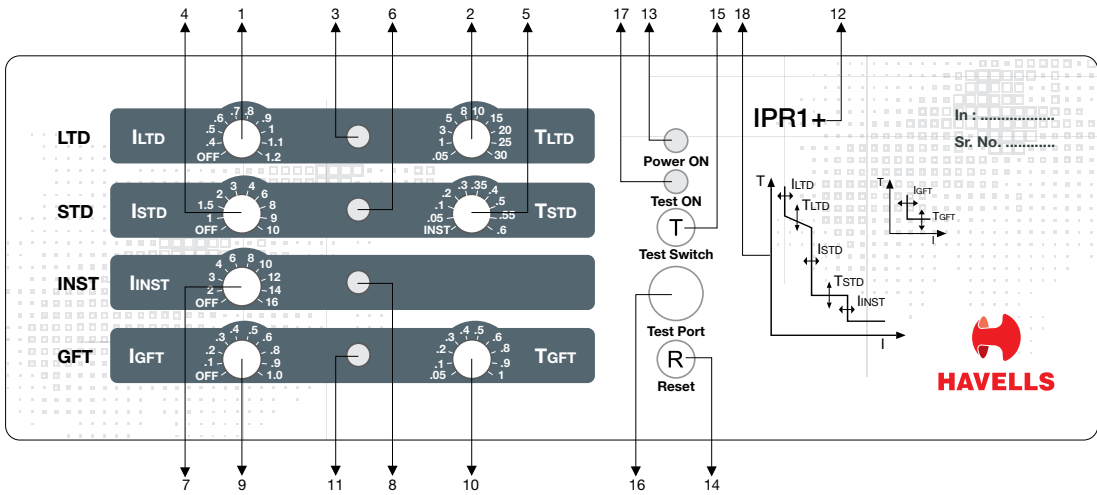

Ref.	Description	Ref.	Description
1	Rotary switch for setting LTD current	10	Rotary switch for setting GFT time
2	Rotary switch for setting LTD Time	11	LED indication for GFT fault
3	LED indication for LTD fault	12	Product identification code
4	Rotary switch for setting STD current	13	LED for "Power ON"
5	Rotary switch for setting STD time	14	Reset push button
6	LED indication for STD fault	15	Test push button
7	Rotary switch for setting INST current	16	Socket for test supply
8	LED indication for INST fault	17	LED for "Test ON"
9	Rotary switch for setting GFT current	18	Time current characteristics curve

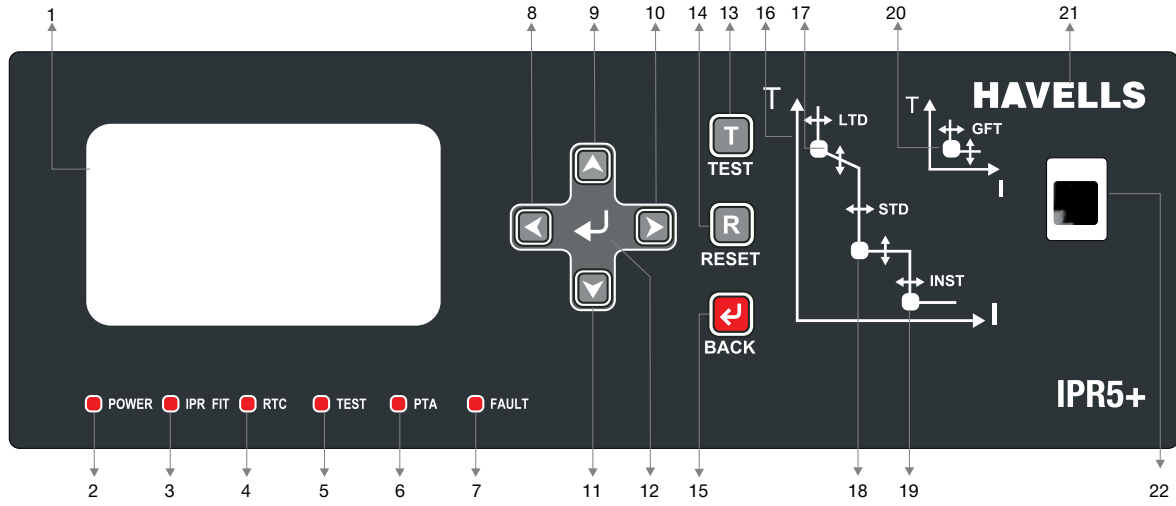

Ref.	Description	Ref.	Description
1	LCD Screen	12	Enter / Save Push Button
2	LED for "Power ON"	13	Test Push Button
3	LED for "IPR Fit"	14	Reset Push Button
4	#LED for "RTC (Ready to Close)"	15	Back Push Button
5	LED for "Test ON"	16	Time Current Characteristic Curve
6	LED for "PTA (Pre-Trip Alarm)"	17	LED Indication for LTD Fault
7	LED for "Faults"	18	LED Indication for STD Fault
8	Scroll "Left" Push Button	19	LED Indication for INST Fault
9	Scroll "Up" Push Button	20	LED Indication for GFT Fault
10	Scroll "Right" Push Button	21	Product Identification Code
11	Scroll "Down" Push Button	22	MODBUS RS-485 Communication Port

# Titania Air Circuit Breaker

(Conforms to IS/IEC:60947-2)

## New Range of Intelligent Protection Release (IPR)+



S. No.	Features	IPR E+	IPR 1+	IPR 3+	IPR 5+
	Release settings:	●	●	●	●
1	LTD	Current Setting	●	●	●
		Time Setting	●	●	●
2	STD	Current Setting	●	●	●
		Time Setting	●	●	●
3	INST	●	●	●	●
4	GFT	Current Setting	●	●	●
		Time Setting	●	●	●
5	PTA	Current Setting		●	●
		Time Setting		●	●
6	Function Blocking	●	●	●	●
7	Field Test Function	●	●	●	●
8	IPR Fit Indicator			●	●
9	Load Shedding Function			●	●
10	Reset Function	●	●	●	●
11	Thermal Memory			●	●
12	LED Indications	●	●	●	●
13	Fault History on Display			●	●
14	Making Current Release	●	●	●	●
15	Zone Selectivity			●	●
16	Circuit Breaker Fail Protection			●	●
17	Operation Counter			●	●
18	Contact Erosion Indicator			●	●
19	Ready to Close (RTC)*			●	●
20	I <sub>2t</sub> ON/OFF			●	●
21	LCD Display			●	●
22	Bar Graphs Indication			●	●
23	External Relay Card*			●	●
	Advanced Protection			●	●
24	Under Voltage Release			●	●
25	Over Voltage Release			●	●
26	Under Frequency protection			●	●
27	Over Frequency protection			●	●
28	Voltage unbalance protection			●	●
29	Phase sequence protection			●	●
30	Over Temperature Protection			●	●
	Measurement Module			●	●
31	Current (Both in 3 phase & neutral)			●	●
32	Voltage (both Line & Phase)			●	●
33	Frequency			●	●
34	Temperature (°C)			●	●
35	Maximum Demand				●
36	Apparent Power (kVA)				●
37	Real Power (kW)				●
38	Reactive Power (kVAr)				●
39	Power factor				●
40	Communication Enabled (MODBUS)				●

\*Provided on request.

Communication software provided on request.

Note: IPR+ releases do not require any external power supply for their basic protection functioning. For other functions and display to run, they require an external power supply of 12 Vdc - 24 Vdc.

# Titania+

Air Circuit Breaker

Rating	Rated Ultimate Short-circuit Breaking Capacity Ics = 100 % Icu at 415 V	Pole	MANUAL		ELECTRICAL	
			Fixed	Drawout	Fixed	Drawout
400 A - 1600 A	65 kA	4 Pole		POR		POR
2000 A - 2500 A	85 kA					
3200 A	100 kA	3 Pole / 4 Pole	Price on Request			
4000 A						
5000 A						
6300 A						



## Protection Release for Titania+

Model Name	N Type	A Type	P Type	H Type
	LN	LA	LP	LH
Frequency				
50 Hz / 60 Hz	50 Hz	50 Hz	50 Hz	50 Hz
Control Power				
External Power	-	●	●	●
Self-Power	●	●	●	●
Protection Function				
LTD (Long Time)	●	●	●	●
STD (Short Time)	●	●	●	●
INST (Instantaneous)	●	●	●	●
Pre-Trip Alarm	-	●	●	●
Ground Fault Trip	●	●	●	●
Thermal Function	●	●	●	●
Field Test	-	●	●	●
Fail Safe	●	●	●	●
Indication				
True RMS Detection Method	●	●	●	●
LED Indication per Trip Type	-	●	●	●
Fault LED	L <sup>1)</sup>	PTA, L, S/I, G	PTA, L, S/I, G	PTA, L, S/I, G
Real-Time LCD Indication of Load Rate per Phase	-	●	●	●
Measurement LCD	-	●	●	●
3 Phase current	-	●	●	●
Voltage	-	-	●	●
Power	-	-	●	●
Power factor & power quantity	-	-	●	●
Demand	-	-	●	●
Zone selective interlocking	-	●	●	●
Voltage / current harmonics (1st ~ 63 th)	-	-	-	●
3 Phase wave form	-	-	-	●
TDH, TDD	-	-	-	●
Output Contact				
Integrated Instantaneous Contact (1a)	●	-	-	-
Individual Continuous Contact (4a)	-	●	●	●
Operation				
MCR	-	○	○	○
Communication	NFC	Modbus-RTU	Modbus-RTU	Modbus-RTU
Event/Fault Recording	●	●	●	●

\* Please refer table A to Product price list  
Door Flange (Escutcheon Frame) is supplied alongwith ACB

● Standard m: Option  
1) Indicates reserve before operation during long time delay.

# ACB Order Form

Please check  in front of appropriate box. Fill separate sheet for each type of ACB

CUSTOMER/ DEALER NAME	ORDER NO./DATE	END USER NAME					
Rating of ACB	630 A <input type="checkbox"/>	1000 A <input type="checkbox"/>	1600 A <input type="checkbox"/>	2500 A <input type="checkbox"/>	4000 A <input type="checkbox"/>	6300 A <input type="checkbox"/>	Qty.
	800 A <input type="checkbox"/>	1250 A <input type="checkbox"/>	2000 A <input type="checkbox"/>	3200 A <input type="checkbox"/>	5000 A <input type="checkbox"/>		
Breaking Capacity Icu	Upto 2500 A	50 kA <input type="checkbox"/>	65 kA <input type="checkbox"/>	75 kA <input type="checkbox"/>			
	3200 A to 6300 A		100 kA <input type="checkbox"/>	150 kA <input type="checkbox"/>			
No. of Poles	3 <input type="checkbox"/>		4 <input type="checkbox"/>		4 <input type="checkbox"/>		
			(100% Neutral)		(50% Neutral for V-Series only)		
Mounting	Fixed <input type="checkbox"/>	Drawout <input type="checkbox"/>	Standard (for E&S series) <input type="checkbox"/>				
			Vertical terminals (for H&V series) <input type="checkbox"/>				
Note: For E & S series - Adapter terminals are on demand							
Spring Charging Operation	Manual <input type="checkbox"/>	Electrical <input type="checkbox"/>	Closing Coil ____ VAC / DC				
			Tripping Coil ____ VAC / DC				
			Motor ____ V				
Release	Upto 2500 A	<input type="checkbox"/>	<input type="checkbox"/>	<input type="checkbox"/>	<input type="checkbox"/>	<input type="checkbox"/>	
		Without Release	IPR E +	IPR 1 +	IPR 3 +	IPR 5 +	
	3200 A to 6300 A	<input type="checkbox"/>	<input type="checkbox"/>	<input type="checkbox"/>	<input type="checkbox"/>	<input type="checkbox"/>	
		Without Release	LN	LA	LP	LH	
Setting: O/L ____ A, S/C ____ A, Inst. ____ A, GFT ____ A, CT Rating ____ A, Neutral CT <input type="checkbox"/>							
<b>Note:</b> Unless otherwise specified O/L will be set at maximum value and all other settings would be set at mid values.							
Other Accessories	Close open cycle counter	<input type="checkbox"/>	Five c/o additional Aux. contacts	<input type="checkbox"/>			
	Field test unit	<input type="checkbox"/>	Shunt Trip	<input type="checkbox"/>			
	Position Indication Switch	<input type="checkbox"/>	UVT	<input type="checkbox"/>			
	Spring Charge Indication Switch	<input type="checkbox"/>	Trip Indication Switch	<input type="checkbox"/>			
	Door Interlock	<input type="checkbox"/>	Key Interlock	1 Lock+1Key <input type="checkbox"/>			
				2 Lock+1Key <input type="checkbox"/>			
				3 Lock+2Key <input type="checkbox"/>			

- Note :
- Please specify the voltages for closing coil, shunt trip coil and UVT, available voltages are 24 VDC, 110 VAC / DC, 220 VAC / DC and 415 VAC and for motor available voltages are 220 VAC / DC and 110 VAC / DC.
  - For details of Protection Releases, please refer the chart of technical features.



## Moulded Case Circuit Breaker

**NEW  
LAUNCH**

**EFFICIENCY UNLEASHED  
COMPACT, SAFE, RELIABLE**

- Range : 16 A – 630 A
- No. of Poles : 3 Pole & 4 Pole
- Breaking Capacity  $I_{cs} = I_{cu} = 100\%$  upto 70 kA
- Ambient Temperature 50 °C
- Operational Voltage 690 V AC
- Insulation Voltage 1000 V AC
- Adjustable Thermal & Magnetic
- Microprocesor Based – LSI, Advance protection
- Digital Display, Communication with Cloud connectivity



### Specifications and Certifications

- IEC 60947-1 & 2
- RoHS Compliant

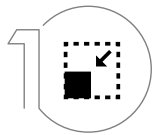

Compact Footprint



Quick Toggle, Trip free mechanism



Current Limiting, outstanding single break



Positive Isolation

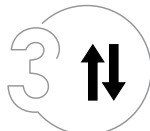

Line-Load Reversibility

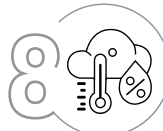

Suitable for harsh Environments



Reliable breaking performance,  $I_{cs}=100\% I_{cu}$



Trip Intelligence



Class II Insulation

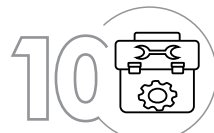

Easy and Field Installable accessories



## QTRON 160

### Adjustable Thermal & Fixed Magnetic

Rated Ultimate Short-circuit Breaking Capacity Ics=100% Icu at 415 V AC (kA rms)	Rated Service Short-circuit Breaking Capacity Ics = % Icu at 415 V (kArms)	Current Rating (A)	Three Pole Cat. No	Per Unit LP (₹)	Four Pole Cat. No	Per Unit LP (₹)
36 kA	100%	16 A	IHQT1EB30016	14335.00	IHQT1EB50016	17795.00
		25 A	IHQT1EB30025	14335.00	IHQT1EB50025	17795.00
		32 A	IHQT1EB30032 ▲	14335.00	IHQT1EB50032	17795.00
		40 A	IHQT1EB30040	14335.00	IHQT1EB50040	17795.00
		50 A	IHQT1EB30050	14335.00	IHQT1EB50050	17795.00
		63 A	IHQT1EB30063 ▲	13805.00	IHQT1EB50063 ▲	17140.00
		80 A	IHQT1EB30080	13805.00	IHQT1EB50080	17140.00
		100 A	IHQT1EB30100 ▲	13805.00	IHQT1EB50100 ▲	17140.00
		125 A	IHQT1EB30125 ▲	15525.00	IHQT1EB50125 ▲	19100.00
		160 A	IHQT1EB30160 ▲	20365.00	IHQT1EB50160 ▲	24160.00
50 kA	100%	16 A	IHQT1FB30016	18855.00	IHQT1FB50016	23100.00
		25 A	IHQT1FB30025	18855.00	IHQT1FB50025	23100.00
		32 A	IHQT1FB30032	18855.00	IHQT1FB50032	23100.00
		40 A	IHQT1FB30040	18855.00	IHQT1FB50040	23100.00
		50 A	IHQT1FB30050	18855.00	IHQT1FB50050	23100.00
		63 A	IHQT1FB30063	18165.00	IHQT1FB50063 ▲	22250.00
		80 A	IHQT1FB30080	18165.00	IHQT1FB50080	22250.00
		100 A	IHQT1FB30100	18165.00	IHQT1FB50100 ▲	22250.00
		125 A	IHQT1FB30125 ▲	24170.00	IHQT1FB50125 ▲	27900.00
		160 A	IHQT1FB30160	27420.00	IHQT1FB50160 ▲	32830.00

### Motor Protection MCCB

Rated Ultimate Short-circuit Breaking Capacity Ics=100% Icu at 415 V AC (kA rms)	Rated Service Short-circuit Breaking Capacity Ics = % Icu at 415 V (kArms)	Current Rating (A)	Three Pole Cat. No	Per Unit LP (₹)
50 kA	100%	40 A	IHQT1FD30040MP	8020.00
		50 A	IHQT1FD30050MP	8020.00
		63 A	IHQT1FD30063MP	8020.00
		80 A	IHQT1FD30080MP	8020.00
		100 A	IHQT1FD30100MP	10460.00
		125 A	IHQT1FD30125MP	10575.00
		160 A	IHQT1FD30160MP	12550.00

▲ Stockable Item

For details on technical parameters & non stockable items contact nearest sales office.

Note: Phase barriers are supplied along with MCCBs

Spreader terminals are available as an accessories, refer page no. 21

It is recommended to use spreader terminals for enhancing termination capacity



## QTRON 250

### Adjustable Thermal & Adjustable Magnetic

Rated Ultimate Short-circuit Breaking Capacity I <sub>cs</sub> =100% I <sub>cu</sub> at 415 V AC (kA rms)	Rated Service Short-circuit Breaking Capacity I <sub>cs</sub> = % I <sub>cu</sub> at 415 V (kArms)	Current Rating (A)	Three Pole Cat. No.	Per Unit LP (₹)	Four Pole Cat. No.	Per Unit LP (₹)
36 kA	100%	100 A	IHQT2EC30100	22540.00	IHQT2EC50100	27890.00
		125 A	IHQT2EC30125	22540.00	IHQT2EC50125	27890.00
		160 A	IHQT2EC30160	28665.00	IHQT2EC50160 ▲	35365.00
		200 A	IHQT2EC30200 ▲	29790.00	IHQT2EC50200 ▲	37165.00
		250 A	IHQT2EC30250 ▲	33465.00	IHQT2EC50250 ▲	40810.00
50 kA		100 A	IHQT2FC30100	31225.00	IHQT2FC50100	38040.00
		125 A	IHQT2FC30125	31225.00	IHQT2FC50125	38040.00
		160 A	IHQT2FC30160	33005.00	IHQT2FC50160	41630.00
		200 A	IHQT2FC30200	35230.00	IHQT2FC50200	43435.00
		250 A	IHQT2FC30250	37755.00	IHQT2FC50250	47490.00

## Microprocessor MCCB - LSI

Rated Ultimate Short-circuit Breaking Capacity I <sub>cs</sub> =100% I <sub>cu</sub> at 415 V AC (kA rms)	Rated Service Short-circuit Breaking Capacity I <sub>cs</sub> = % I <sub>cu</sub> at 415 V (kArms)	Current Rating (A)	Three Pole Cat. No.	Per Unit LP (₹)	Four Pole Cat. No.	Per Unit LP (₹)
36 kA	100%	40 A	IHQT2EE30040	31080.00	IHQT2EE50040	39865.00
		63 A	IHQT2EE30063	31080.00	IHQT2EE50063	39865.00
		100 A	IHQT2EE30100	31080.00	IHQT2EE50100	39865.00
		160 A	IHQT2EE30160	40580.00	IHQT2EE50160	56395.00
		250 A	IHQT2EE30250	42610.00	IHQT2EE50250	59020.00
50 kA		40 A	IHQT2FE30040	37190.00	IHQT2FE50040	49315.00
		63 A	IHQT2FE30063	37190.00	IHQT2FE50063	49315.00
		100 A	IHQT2FE30100	37190.00	IHQT2FE50100	49315.00
		160 A	IHQT2FE30160	48215.00	IHQT2FE50160	61585.00
		250 A	IHQT2FE30250	50245.00	IHQT2FE50250	63675.00

## Microprocessor MCCB - LSI G

Rated Ultimate Short-circuit Breaking Capacity I <sub>cs</sub> =100% I <sub>cu</sub> at 415 V AC (kA rms)	Rated Service Short-circuit Breaking Capacity I <sub>cs</sub> = % I <sub>cu</sub> at 415 V (kArms)	Current Rating (A)	Three Pole Cat. No.	Per Unit LP (₹)	Four Pole Cat. No.	Per Unit LP (₹)
36 kA	100%	40 A	IHQT2EF30040	40580.00	IHQT2EF50040	50125.00
		63 A	IHQT2EF30063	40580.00	IHQT2EF50063	50125.00
		100 A	IHQT2EF30100	40580.00	IHQT2EF50100	50125.00
		160 A	IHQT2EF30160	56110.00	IHQT2EF50160	68665.00
		250 A	IHQT2EF30250	57220.00	IHQT2EF50250	70350.00
50 kA		40 A	IHQT2FF30040	40580.00	IHQT2FF50040	61465.00
		63 A	IHQT2FF30063	46785.00	IHQT2FF50063	61465.00
		100 A	IHQT2FF30100	46785.00	IHQT2FF50100	61465.00
		160 A	IHQT2FF30160	58455.00	IHQT2FF50160	71625.00
		250 A	IHQT2FF30250	59465.00	IHQT2FF50250	72965.00

## Motor Protection MCCB

Rated Ultimate Short-circuit Breaking Capacity I <sub>cs</sub> =100% I <sub>cu</sub> at 415 V AC (kA rms)	Rated Service Short-circuit Breaking Capacity I <sub>cs</sub> = % I <sub>cu</sub> at 415 V (kArms)	Current Rating (A)	Three Pole Cat. No.	Per Unit LP (₹)
50 kA	100%	200 A	IHQT2FD30200MP	25065.00
		250 A	IHQT2FD30250MP	29450.00

▲ Stockable Item

For details on technical parameters & non stockable items contact nearest sales office.

Note: Phase barriers are supplied along with MCCBs

Spreader terminals are available as an accessories, refer page no. 21

It is recommended to use spreader terminals for enhancing termination capacity

For material availability please connect with nearest sales office.

# QTRON QT3

Moulded Case Circuit Breaker

(Conforms to IS/IEC 60947-2)



## QTRON 630 Microprocessor MCCB - LSI

Rated Ultimate Short-circuit Breaking Capacity Ics=100% Icu at 415 V AC (kA rms)	Rated Service Short-circuit Breaking Capacity Ics = % Icu at 415 V (kArms)	Current Rating (A)	Three Pole Cat. No.	Per Unit LP (₹)	Four Pole Cat. No.	Per Unit LP (₹)
36 kA	100%	400A	IHQT3EE30400	58290.00	IHQT3EE50400	72205.00
		630A	IHQT3EE30630	62635.00	IHQT3EE50630	90255.00
50 kA		400A	IHQT3FE30400	64700.00	IHQT3FE50400	79425.00
		630A	IHQT3FE30630	69525.00	IHQT3FE50630	98375.00
70 kA		400A	IHQT3HE30400	78935.00	IHQT3HE50400	99280.00

## Microprocessor MCCB - LSI G

Rated Ultimate Short-circuit Breaking Capacity Ics=100% Icu at 415 V AC (kA rms)	Rated Service Short-circuit Breaking Capacity Ics = % Icu at 415 V (kArms)	Current Rating (A)	Three Pole Cat. No.	Per Unit LP (₹)	Four Pole Cat. No.	Per Unit LP (₹)
36 kA	100%	400A	IHQT3EF30400	65285.00	IHQT3EF50400	80870.00
		630A	IHQT3EF30630	70150.00	IHQT3EF50630	101085.00
50 kA		400A	IHQT3FF30400	72465.00	IHQT3FF50400	88955.00
		630A	IHQT3FF30630	77870.00	IHQT3FF50630	110180.00
70 kA		400A	IHQT3HF30400	98805.00	IHQT3HF50400	123685.00

Note: Phase barriers are supplied along with MCCBs  
 Spreader terminals are available as an accessories, refer page no. 21  
 It is recommended to use spreader terminals for enhancing termination capacity  
 For material availability please connect with nearest sales office.

### Accessories

Description	Cat. No	Per Unit LP (₹)
<b>Shunt Trip - QT160, QT250 &amp; QT630</b>		
24 Vdc	ISSLQX0172	POR
48 Vdc	ISSLQX0173	
110 Vdc	ISSLQX0175	
110 V AC	ISSLQX0176	3380.00
230 V AC ▲	ISSLQX0171	3380.00
415 V AC	ISSLQX0177	3380.00
<b>Under Voltage Release - QT160, QT250 &amp; QT630</b>		
24 Vdc	ISSLQX0180	POR
48 Vdc	ISSLQX0181	
110 Vdc ▲	ISSLQX0182	
110 V AC	ISSLQX0183	4260.00
230 V AC	ISSLQX0179	4260.00
415 V AC	ISSLQX0184	4260.00
<b>Auxillary Contact - QT160, QT250 &amp; QT630</b>		
1 C/O ▲	ISSLQX0149	1285.00
2 C/O	ISSLQX0242	2455.00
<b>Trip Alarm Contact - QT160, QT250 &amp; QT630</b>		
1 C/O	ISSLQX0145	1285.00
<b>Auxillary + Alarm Contact - QT160, QT250 &amp; QT630</b>		
1 C/O + 1 C/O ▲	ISSLQX0164	2455.00
<b>Spreader Terminals Kit</b>		
Spreader Terminal Kit (3nos) QT160 ▲	ISSLQX0015	1085.00
Spreader Terminal Kit (4nos) QT160 ▲	ISSLQX0014	1405.00
Spreader Terminal Kit (3nos) QT250	ISSLQX0542	1220.00
Spreader Terminal Kit (4nos) QT250	ISSLQX0543	1615.00
Spreader Terminal Kit (3nos) QT630*	ISSLQX0319	3600.00
Spreader Terminal Kit (4nos) QT630*	ISSLQX0320	4800.00
<b>Rotary Handle</b>		
Direct Mounting QT160	ISSLQX0222	1785.00
Door Mounting QT160 ▲	ISSLQX0223	2760.00
Direct Mounting QT250 ▲	ISSLQX0325	1910.00
Door Mounting QT250	ISSLQX0326	3295.00
Door Mounting QT630	ISSLQX0413	5635.00
<b>Pad Lock</b>		
Fixed QT160	ISSLQX0209	270.00
Removable QT160	ISSLQX0211	185.00
Fixed QT250	ISSLQX0408	290.00
Removable QT250	ISSLQX0409	265.00
<b>Terminal Shroud</b>		
3 Pole QT160	ISSLQX0141	725.00
4 Pole QT160	ISSLQX0142	1000.00
3 Pole QT250 ▲	ISSLQX0167	1395.00
4 Pole QT250 ▲	ISSLQX0168	1740.00
3 Pole QT630	ISSLQU0448	1620.00
4 Pole QT630	ISSLQU0449	2085.00
<b>MCCB Enclosure</b>		
3 Pole QT160	ISSLQX0381	2720.00
4 Pole QT160 ▲	ISSLQX0385	2720.00
3 Pole QT250	ISSLQX0440	3335.00
4 Pole QT250	ISSLQX0446	3335.00
<b>Din Mounting Plant</b>		
QT160 A	ISSLQX0208	195.00

▲ Stockable Item

For details on technical parameters & non stockable items contact nearest sales office.

\*For 630 A 2 numbers of spreader terminals kit to be ordered for each size (Load & Line).



# A'TRON

## Moulded Case Circuit Breaker

(Conforms to IS/IEC 60947-2)

Range : 16 A – 160 A

No. of Poles : 3 Pole & 4 Pole

Breaking Capacity  $I_{cs} = I_{cu} = 100\%$  upto 25 kA

Ambient Temperature 40 °C

Operational Voltage 415 V AC

Insulation Voltage 1000 V AC

Imp Voltage 8 kV

Adjustable Thermal Fixed Magnetic

Field fittable accessories



### Specifications and Certifications

IEC 60947-1 & 2

RoHS Compliant

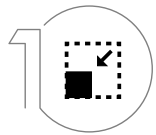

Compact Footprint

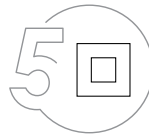

Class II Insulation



Current Limiting, outstanding single break



Quick Toggle, Trip free mechanism

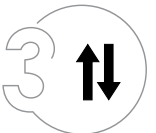

Line-Load Reversibility



Positive Isolation



Reliable breaking performance,  $I_{cs}=100\% I_{cu}$

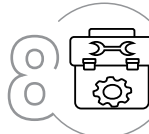

Easy and Field Installable accessories

# ATRON

## Moulded Case Circuit Breaker

(Conforms to IS/IEC 60947-2)



## ATRON 160

### Adjustable Thermal & Fixed Magnetic

Rated Ultimate Shortcircuit Breaking Capacity Icu at 415 V (kA rms)	Rated Service short circuit Breaking Capacity Ics at 415 V (kA rms)	Current Rating (A)	Three Pole Cat. No.	Per Unit LP (₹)	Four Pole \$ Cat. No.	Per Unit LP (₹)
18 kA	18 kA	16 A	IHTT1IB30016	6805.00	IHTT1IB50016	8460.00
		20 A	IHTT1IB30020	6805.00	IHTT1IB50020	8460.00
		25 A	IHTT1IB30025	6805.00	IHTT1IB50025	8460.00
		32 A ▲	IHTT1IB30032	6805.00	IHTT1IB50032	8460.00
		40 A	IHTT1IB30040	6805.00	IHTT1IB50040	8460.00
		50 A	IHTT1IB30050	6805.00	IHTT1IB50050	8460.00
		63 A ▲	IHTT1IB30063	6590.00	IHTT1IB50063	8315.00
		80 A	IHTT1IB30080	6590.00	IHTT1IB50080	8315.00
		100 A ▲	IHTT1IB30100	6590.00	IHTT1IB50100	8315.00
		125 A ▲	IHTT1IB30125	6810.00	IHTT1IB50125	8565.00
		160 A ▲	IHTT1IB30160	8080.00	IHTT1IB50160	10095.00
25 kA	25 kA	16 A	IHTT1DB30016	10485.00	IHTT1DB50016	12405.00
		20 A	IHTT1DB30020	10485.00	IHTT1DB50020	12405.00
		25 A	IHTT1DB30025	10485.00	IHTT1DB50025	12405.00
		32 A	IHTT1DB30032	10485.00	IHTT1DB50032	12405.00
		40 A	IHTT1DB30040	10485.00	IHTT1DB50040	12405.00
		50 A	IHTT1DB30050	10485.00	IHTT1DB50050	12405.00
		63 A ▲	IHTT1DB30063	10610.00	IHTT1DB50063	12200.00
		80 A	IHTT1DB30080	10610.00	IHTT1DB50080	12200.00
		100 A ▲	IHTT1DB30100	10610.00	IHTT1DB50100	12200.00
		125 A ▲	IHTT1DB30125	12060.00	IHTT1DB50125	14950.00
		160 A	IHTT1DB30160	14145.00	IHTT1DB50160	17170.00

### Adjustable Thermal & Fixed Magnetic

Rated Ultimate Shortcircuit Breaking Capacity Icu at 415 V (kA rms)	Rated Service short circuit Breaking Capacity Ics at 415 V (kA rms)	Current Rating (A)	Three Pole Cat. No.	Per Unit LP (₹)	Four Pole (wSN) Cat. No.##	Per Unit LP (₹)
18 kA	18 kA	16 A	IHTT1IB30016	6805.00	IHTT1IB40016	8035.00
		20 A	IHTT1IB30020	6805.00	IHTT1IB40020	8035.00
		25 A	IHTT1IB30025	6805.00	IHTT1IB40025	8035.00
		32 A ▲	IHTT1IB30032	6805.00	IHTT1IB40032	8035.00
		40 A	IHTT1IB30040	6805.00	IHTT1IB40040	8035.00
		50 A	IHTT1IB30050	6805.00	IHTT1IB40050	8035.00
		63 A ▲	IHTT1IB30063	6590.00	IHTT1IB40063	7775.00
		80 A	IHTT1IB30080	6590.00	IHTT1IB40080	7775.00
		100 A ▲	IHTT1IB30100	6590.00	IHTT1IB40100	7775.00
		125 A ▲	IHTT1IB30125	6810.00	IHTT1IB40125	8025.00
		160 A ▲	IHTT1IB30160	8080.00	IHTT1IB40160	9360.00
25 kA	18 kA	16 A	IHTTHDB30016	7495.00	IHTTHDB40016	9435.00
		20 A	IHTTHDB30020	7495.00	IHTTHDB40020	9435.00
		25 A	IHTTHDB30025	7495.00	IHTTHDB40025	9435.00
		32 A	IHTTHDB30032	7495.00	IHTTHDB40032	9435.00
		40 A ▲	IHTTHDB30040	7495.00	IHTTHDB40040	9435.00
		50 A	IHTTHDB30050	7495.00	IHTTHDB40050	9435.00
		63 A ▲	IHTTHDB30063	7305.00	IHTTHDB40063	9195.00
		80 A	IHTTHDB30080	7305.00	IHTTHDB40080	9195.00
		100 A ▲	IHTTHDB30100	7305.00	IHTTHDB40100	9195.00
		125 A ▲	IHTTHDB30125	7905.00	IHTTHDB40125	10385.00
		160 A ▲	IHTTHDB30160	11735.00	IHTTHDB40160	13565.00

▲ Stockable Item  
For details on technical parameters & non stockable items contact nearest sales office.

Note: Phase barriers are supplied along with MCCBs  
Spreader terminals are available as an accessories, refer page no. 24  
It is recommended to use spreader terminals for enhancing termination capacity

For material availability please connect with nearest sales office.  
##FP with Switched Neutral (unprotected neutral)  
\$-Neutral pole protected

Effective from 1st April, 2026

List Price (LP) are in Indian ₹ & as per Standard Terms & Conditions **HAVELLS** 23

## ATRON 160

### Accessories

Description	Cat. No	Per Unit LP (₹)
Shunt Trip		
110 V AC	ISSLQX0176	3380.00
230 V AC ▲	ISSLQX0171	
415 V AC	ISSLQX0177	
Under Voltage Release		
110 V AC	ISSLQX0183	4260.00
230 V AC ▲	ISSLQX0179	
415 V AC	ISSLQX0184	
Auxillary Contact		
1 C/O ▲	ISSLQX0149	1285.00
2 C/O	ISSLQX0242	2455.00
Trip Alarm Contact		
1 C/O	ISSLQX0145	1285.00
Auxillary + Alarm Contact		
1 C/O + 1 C/O ▲	ISSLQX0164	2455.00
Spreader Terminals kit		
Spreader Terminal Kit (3NOS) AT1 - 16 A to 100 A	ISSLEX1158 ▲	375.00
Spreader Terminal Kit (3NOS) AT1 - 125 A to 160 A	ISSLTX000013	700.00
Spreader Terminal Kit (4NOS) AT1 - 16 A to 100 A	ISSLEX1159 ▲	550.00
Spreader Terminal Kit (4NOS) AT1 - 125 A to 160 A	ISSLTX000014	950.00
Rotary Handle		
Direct Mounting	ISSLQX0222	1785.00
Door Mounting AT160 ▲	ISSLTU0211	2415.00
Pad Lock		
Fixed	ISSLQX0209	270.00
Removable	ISSLQX0211	185.00
MCCB Enclosure		
3 Pole ▲	ISSLQX0381	2720.00
4 Pole ▲	ISSLQX0385	



▲ Stockable Item

For details on technical parameters & non stockable items contact nearest sales office.

Note: Phase barriers are supplied along with MCCBs

Spreader terminals are available as an accessories, refer page no. 24

It is recommended to use spreader terminals for enhancing termination capacity

For material availability please connect with nearest sales office.

# Loadline Moulded Case Circuit Breakers

(Conforms to IS/IEC:60947-2)

## GA Frame

### Fixed Thermal & Fixed Magnetic

HSN Code: 85362020

Rated Ultimate Shortcircuit Breaking Capacity Icu at 415 V (kA rms)	Rated Service short circuit Breaking Capacity Ics = % Icu at 415 V (kA rms)	Current Rating (A)	Three Pole Cat. No.	Per Unit LP (₹)
10 kA	50%	63 A	IHLGAAAT0063	3010.00
		80 A	IHLGAAA30080	3010.00
		100 A ▲	IHLGAAA30100	3010.00
		125 A ▲	IHLGAAA30125	3610.00



## G Frame

### Fixed Thermal & Fixed Magnetic

HSN Code: 85362020

Rated Ultimate Shortcircuit Breaking Capacity Icu at 415 V (kA rms)	Rated Service short circuit Breaking Capacity Ics = % Icu at 415 V (kA rms)	Current Rating (A)	Three Pole Cat. No.	Per Unit LP (₹)	Four Pole ## Cat. No.	Per Unit LP (₹)
10 kA	100%	25 A	IHLGST0025	3340.00	IHLGSF0025	4360.00
		32 A	IHLGST0032 ▲	3340.00	IHLGSF0032 ▲	4360.00
		40 A	IHLGST0040	3340.00	IHLGSF0040 ▲	4360.00
		50 A	IHLGST0050	3340.00	IHLGSF0050	4360.00
		63 A	IHLGST0063 ▲	3340.00	IHLGSF0063 ▲	4405.00
		80 A	IHLGS30080	3340.00	IHLGS40080	4695.00
		100 A	IHLGS30100 ▲	3340.00	IHLGS40100 ▲	4695.00
		125 A	IHLGS30125 ▲	4445.00	IHLGS40125 ▲	5145.00
		160 A	IHLGS30160 ▲	5960.00	IHLGS40160 ▲	7890.00

## Single Pole MCCB

HSN Code: 85362020

Rated Ultimate Shortcircuit Breaking Capacity Icu at 240 V AC (kA rms)	Rated Service short circuit Breaking Capacity Ics = % Icu at 240 V AC (kA rms)	Current Rating (A)	Single Pole Cat. No.	Per Unit LP (₹)
10 kA	100%	25 A	IHLGSS0025 ▲	1420.00
		32 A	IHLGSS0032	1420.00
		40 A	IHLGSS0040	1420.00
		50 A	IHLGSS0050	1420.00
		63 A	IHLGSS0063 ▲	1420.00
		80 A	IHLGS10080	1420.00
		100 A	IHLGSAAS0100 ▲	1420.00
		125 A	IHLGSAA10125 ▲	1540.00
		160 A	IHLGS10160 ▲	1635.00

▲ Stockable Item

For details on technical parameters & non stockable items contact nearest sales office.

Adjustable thermal (70%-100%) in TP & FP for A frame  
Adjustable thermal (80%-100%) in TP & FP for L frame  
Please refer catalogue for magnetic adjustability details  
Phase barriers are supplied along with MCCBs  
Spreader terminals are available as an accessories, refer page no. 28  
##FP with Switched Neutral

# Loadline Moulded Case Circuit Breakers

(Conforms to IS/IEC:60947-2)



## A Frame

### Adjustable Thermal & Adjustable Magnetic

HSN Code: 85362020

Rated Ultimate Shortcircuit Breaking Capacity Icu at 415 V (kA rms)	Rated Service short circuit Breaking Capacity Ics = % Icu at 415 V (kA rms)	Current Rating (A)	Suitable for DC Application	Three Pole Cat. No.	Per Unit LP (₹)	Four Pole ## Cat. No.	Per Unit LP (₹)
16 kA	100%	160 A	-	IHLASBC30160 ▲	12595.00	IHLASBC40160 ▲	17290.00
		200 A		IHLASBC30200 ▲	14915.00	IHLASBC40200 ▲	18885.00
25 kA	75%	80 A	(Suitable for DC application 10 kA at 250 V DC 2P in series)	IHLASDC30080	10165.00	IHLASDC40080	12310.00
		100 A		IHLASDC30100 ▲	10165.00	IHLASDC40100 ▲	12310.00
		125 A		IHLASDC30125 ▲	12745.00	IHLASDC40125 ▲	15070.00
		160 A		IHLANDC30160 ▲	15490.00	IHLANDC40160 ▲	18535.00
		200 A		IHLANDC30200 ▲	15705.00	IHLANDC40200 ▲	19320.00
		250 A		IHLANDC30250 ▲	16960.00	IHLANDC40250 ▲	21430.00
25 kA	100%	80 A	(Suitable for DC application 10 kA at 250 V DC 2P in series)	IHLANYC30080	10480.00	IHLANYC40080	13255.00
		100 A		IHLANYC30100 ▲	10480.00	IHLANYC40100 ▲	13255.00
		125 A		IHLANYC30125 ▲	13125.00	IHLANYC40125 ▲	16230.00
		160 A		IHLANYC30160 ▲	17045.00	IHLANYC40160 ▲	20395.00
		200 A		IHLANYC30200 ▲	17275.00	IHLANYC40200 ▲	21250.00
		250 A		IHLANYC30250 ▲	18650.00	IHLANYC40250 ▲	23575.00

## L Frame

### Adjustable Thermal & Fixed Magnetic

HSN Code: 85362020

Rated Ultimate Shortcircuit Breaking Capacity Icu at 415 V (kA rms)	Rated Service short circuit Breaking Capacity Ics = % Icu at 415 V (kA rms)	Current Rating (A)	Three Pole Cat. No.	Per Unit LP (₹)	Four Pole ## Cat. No.	Per Unit LP (₹)
36 kA	100%	200 A	IHLLSEB30200 ▲	30440.00	IHLLSEB40200 ▲	36335.00
		250 A	IHLLSEB30250 ▲	34155.00	IHLLSEB40250 ▲	40800.00
		320 A	IHLLSEB30320 ▲	36725.00	IHLLSEB40320 ▲	45125.00
		400 A	IHLLSEB30400 ▲	36725.00	IHLLSEB40400	45125.00
		500 A	IHLLSEB30500	52000.00	IHLLSEB40500 ▲	65000.00
		630 A	IHLLSEB30630 ▲	52000.00	IHLLSEB40630	65000.00
50 kA	100%	200 A	IHLLSFB30200 ▲	33745.00	IHLLSFB40200 ▲	39945.00
		250 A	IHLLSFB30250 ▲	36505.00	IHLLSFB40250 ▲	43185.00
		320 A	IHLLSFB30320	39440.00	IHLLSFB40320 ▲	47720.00
		400 A	IHLLSFB30400 ▲	39440.00	IHLLSFB40400	47720.00
		500 A	IHLLSFB30500	55995.00	IHLLSFB40500	68745.00
		630 A	IHLLSFB30630 ▲	55995.00	IHLLSFB40630	68745.00

▲ Stockable Item

For details on technical parameters & non stockable items contact nearest sales office.

Adjustable thermal (70%-100%) in TP & FP for A frame  
Adjustable thermal (80%-100%) in TP & FP for L frame  
Please refer catalogue for magnetic adjustability details  
Phase barriers are supplied along with MCCBs  
Spreader terminals are available as an accessories, refer page no. 28  
##FP with Switched Neutral

# Loadline Moulded Case Circuit Breakers

(Conforms to IS/IEC:60947-2)

## L Frame

### Adjustable Thermal & Adjustable Magnetic

HSN Code: 85362020

Rated Ultimate Shortcircuit Breaking Capacity Icu at 415 V (kA rms)	Rated Service short circuit Breaking Capacity Ics = % Icu at 415 V (kA rms)	Current Rating (A)	Three Pole Cat. No.	Per Unit LP (₹)	Four Pole ## Cat. No.	Per Unit LP (₹)
36 kA	100%	200 A	IHLLSEC30200 ▲	31800.00	IHLLSEC40200 ▲	37300.00
		250 A	IHLLSEC30250 ▲	35095.00	IHLLSEC40250 ▲	41685.00
		400 A	IHLLSEC30400 ▲	40310.00	IHLLSEC40400 ▲	49225.00
		630 A	IHLLSEC30630 ▲	52475.00	IHLLSEC40630 ▲	66310.00
50 kA	100%	200 A	IHLLSFC30200	37900.00	IHLLSFC40200	45100.00
		250 A	IHLLSFC30250	41000.00	IHLLSFC40250 ▲	48785.00
		400 A	IHLLSFC30400 ▲	42580.00	IHLLSFC40400 ▲	50880.00
		630 A	IHLLSFC30630 ▲	58650.00	IHLLSFC40630 ▲	70095.00

## Microprocessor MCCB

Adjustable Overload, Short-circuit, Ground fault (4 Pole) & Fixed Instantaneous Neutral Protection (4 Pole)

HSN Code: 85362020

Rated Ultimate Shortcircuit Breaking Capacity Icu at 415 V (kA rms)	Rated Service short circuit Breaking Capacity Ics = % Icu at 415 V (kA rms)	Current Rating (A)	Three Pole Cat. No.	Per Unit LP (₹)	Four Pole ## Cat. No.	Per Unit LP (₹)
36 kA	100%	250 A	IHLLSEE30250 ▲	54900.00	IHLLSEE40250 ▲	6645.00
		400 A	IHLLSEE30400 ▲		IHLLSEE40400 ▲	
		630 A	IHLLSEE30630	61480.00	IHLLSEE40630 ▲	78520.00
50 kA	100%	250 A	IHLLSFE30250	59815.00	IHLLSFE40250	74910.00
		400 A	IHLLSFE30400 ▲		IHLLSFE40400 ▲	
		630 A	IHLLSFE30630 ▲	63930.00	IHLLSFE40630 ▲	83850.00

▲ Stockable Item  
For details on technical parameters & non stockable items contact nearest sales office.

Adjustable thermal (70%-100%) in TP & FP for A frame  
Adjustable thermal (80%-100%) in TP & FP for L frame  
Please refer catalogue for magnetic adjustability details  
Phase barriers are supplied along with MCCBs

Spreader terminals are available as an accessories, refer page no. 28  
##FP with Switched Neutral

Effective from 1st April, 2026

List Price (LP) are in Indian ₹ & as per Standard Terms & Conditions **HAVELLS 27**

# Loadline Moulded Case Circuit Breakers

(Conforms to IS/IEC:60947-2)

## HIM MCCB

### Adjustable Thermal & Fixed Magnetic

HSN Code: 85389000

Rated Ultimate Shortcircuit Breaking Capacity Icu at 415 V (kA rms)	Rated Service short circuit Breaking Capacity Ics = % Icu at 415 V (kA rms)	Current Rating (A)	Three Pole Cat. No.	Per Unit LP (₹)	Four Pole ## Cat. No.	Per Unit LP (₹)
65 kA	100%	800 A	IHD4HLBT0800 ▲	74630.00	IHD4HLBF0800 ▲	96285.00

## MCCB Accessories

### Spreader Terminal kit (1 side)

HSN Code: 85389000

Frame Size	Rating	Pole	FG Codes	Per Unit LP (₹)
G Frame	80 A - 100 A	1P	ISSLGX0153 ▲	100.00
		3P	ISSLGX0154 ▲	260.00
		4P	ISSLGX0155 ▲	410.00
	125 A	1P	ISSLGX0156 ▲	130.00
		3P	ISSLGX0157	400.00
		4P	ISSLGX0158	535.00
	160 A	1P	ISSLGX0159 ▲	155.00
		3P	ISSLGX0160	540.00
		4P	ISSLGX0161	735.00
A Frame	80 A~100 A	3P	ISSLAX0121 ▲	395.00
		4P	ISSLAX0122 ▲	530.00
	125 A~200 A	3P	ISSLAX0124 ▲	800.00
		4P	ISSLAX0125 ▲	1050.00
	250 A	3P	ISSLAX0127 ▲	1150.00
		4P	ISSLAX0128 ▲	1550.00
L Frame	200 A~400 A	3P	ISSLLX0065 ▲	2370.00
		4P	ISSLLX0066 ▲	3100.00
	500 A~630 A	3P	ISSLLX0067 ▲	6200.00
		4P	ISSLLX0068 ▲	8300.00
HIM 800	800 A	3P	ISSLEX1166 ▲	7200.00
		4P	ISSLEX1167 ▲	9800.00

## Enclosures for MCCBs ▲

HSN Code: 85371000

Description	Item Code	Per Unit LP (₹)
GA & 'G' Frame TP	IHEGTP ▲	2745.00
GA & 'G' Frame FP	IHEGFP ▲	
'A' Frame TP	IHEATP ▲	3155.00
'A' Frame FP	IHEAFP ▲	
'L' Frame TP	IHELTP ▲	12685.00
'L' Frame FP	IHELFP ▲	
HIM 800 TP	ISSBOU1199	12980.00
HIM 800 FP	ISSBOU1200	

▲ Stockable Item  
For details on technical parameters & non stockable items contact nearest sales office.

Adjustable thermal (70%-100%) in TP & FP for A frame  
Adjustable thermal (80%-100%) in TP & FP for L frame  
Please refer catalogue for magnetic adjustability details  
Phase barriers are supplied along with MCCBs

Spreader terminals are available as an accessories, refer page no. 28  
##FP with Switched Neutral

# Loadline Moulded Case Circuit Breakers

(Conforms to IS/IEC:60947-2)

## Earth Fault Relay for MCCBs

HSN Code: 85389000

MCCBs Current Range (A)	Item Code**	Per Unit LP (₹)
25 A- 100 A	IHEF1100	10050.00
125 A- 200 A	IHEF2200 ▲	11405.00
250 A- 400 A	IHEF3400 ▲	13315.00
500 A- 800 A	IHEF4800	16605.00



- The above prices are inclusive of CBCT.

\*\* For operating the Earth Fault Relay a Shunt trip or an UVR has to be used.

Note : For operating Shunt Trip for G Frame, a separate auxiliary switch would be required in which case one c/o. will be used with the shunt trip, leaving one c/o. free for use. Door mounting clamps for G & AA Frame are supplied free of cost on request basis.

## Other Accessories

HSN Code: 85389000

Description	'G' / 'GA' Frame		'A' Frame		'L' Frame	
	Item Code	Per Unit LP (₹)	Item Code	Per Unit LP (₹)	Item Code	Per Unit LP (₹)
<b>Shunt Trip</b>						
100 V AC - 110 V AC	ISSLEU2453 ▲	1610.00	IHLAS110	2335.00	IHLLS110	3275.00
220 V AC - 240 V AC	ISSLEU2454 ▲		IHLAS240 ▲		IHLLS240 ▲	
380 V AC - 415 V AC	ISSLEU2446		IHLAS415		IHLLS415 ▲	
<b>Under Voltage Release</b>						
110 V AC - 120 V AC	-	2435.00	IHLAU110	3595.00	IHLLU110	4450.00
220 V AC - 240V AC	ISSLEU2447 ▲		IHLAU240 ▲		IHLLU240 ▲	
380 V AC - 440 V AC	ISSLEU2448 ▲		IHLAU440		IHLLU415 ▲	
<b>Auxiliary Contact (250V AC/250Vdc) (450V AC/250Vdc)</b>						
1-Changeover	ISSLEU2450 ▲	1085.00	IHLAA1CO ▲	1200.00	IHLA1CO ▲	1380.00
2-Changeover	ISSLEU2449	1735.00	IHLAA2CO ▲	1980.00	IHLA2CO ▲	2385.00
<b>Rotary Handle</b>						
Direct Mounting	IHLGD000 ▲	1645.00	IHLAD000 ▲	2160.00		
Door Mounting	IHLGRN30 ▲	2050.00	IHLARN30 ▲	2820.00	IHLRN30 ▲	4175.00
<b>Padl Lock Device</b>						
Padlock	IHLDPG125	165.00	IHLDPA250	250.00	IHLPP000	570.00
Trip Alarm Contact	ISSLEU2451	1085.00	IHLALA1CO	1200.00	IHLB000 ▲	1380.00
<b>Auxiliary Contact + Alram Switch</b>					ISSLEU1772	2385.00

▲ Stockable Item

For details on technical parameters & non stockable items contact nearest sales office.

Adjustable thermal (70%-100%) in TP & FP for A frame  
Adjustable thermal (80%-100%) in TP & FP for L frame  
Please refer catalogue for magnetic adjustability details  
Phase barriers are supplied along with MCCBs  
Spreader terminals are available as an accessories, refer page no. 28  
##FP with Switched Neutral

# Loadline Moulded Case Circuit Breakers

(Conforms to IS/IEC:60947-2)

## Accessories for HIM Series Moulded Case Circuit Breakers

HSN Code: 85389000

Description	HIM 800 Frame	Per Unit LP (₹)
<b>Shunt Trip</b>		
24 Vdc	ISSLEU0889	3360.00
100 Vdc -125 Vdc	ISSLEU0907	
100 V AC -120 V AC	ISSLEU0908	
200 V AC -250 V AC	ISSLEU0890 ▲	
380 V AC - 415 V AC	On Request	
<b>Under Voltage Release</b>		
24 Vdc	ISSLEU0912	4770.00
100 V AC - 120 V AC	ISSLEU0914	
200 V AC - 230 V AC	ISSLEU0895	
380 V AC - 415 V AC	ISSLEU0896	
<b>Auxiliary Contact (250 V AC / 250 Vdc) (450 V AC / 250 Vdc)</b>		
1-Changeover	ISSLEU0793 ▲	1420.00
Alarm Switch (Left side only)	ISSLEU0796	1420.00



SHT



AUX



UVT

HSN Code: 85389000

Description	HIM 800 Frame	Per Unit LP (₹)
<b>Rotary Handle</b>		
Direct Mounting	ISSLEU0916	4180.00
Door Mounting	ISSLEU0824 ▲	5460.00
<b>Mechanical Interlock</b>		
3 Pole	ISSLEU0838 ▲	7510.00
4 Pole (R-S-T-N)	ISSLEU0842 ▲	8905.00
<b>Motor Operator</b>		
24 Vdc	ISSLEU0903 ▲	64795.00
110 V AC / Vdc	ISSLEU0923 ▲	
240 V AC / Vdc	ISSLEU0904	
Pad Lock Device	ISSLEU0845	1955.00
Auxiliary Handle	ISSLEU0846	1955.00
<b>Phase Barrier</b>		
3 Pole (Set of 2)	ISSLEU0885	910.00
4 Pole (Set of 3)	ISSLEU0886	1360.00



Extended Rotary Handle



Motor Operator

▲ Stockable Item  
For details on technical parameters & non stockable items contact nearest sales office.

Adjustable thermal (70%-100%) in TP & FP for A frame  
Adjustable thermal (80%-100%) in TP & FP for L frame  
Please refer catalogue for magnetic adjustability details  
Phase barriers are supplied along with MCCBs  
Spreader terminals are available as an accessories, refer page no. 28  
##FP with Switched Neutral

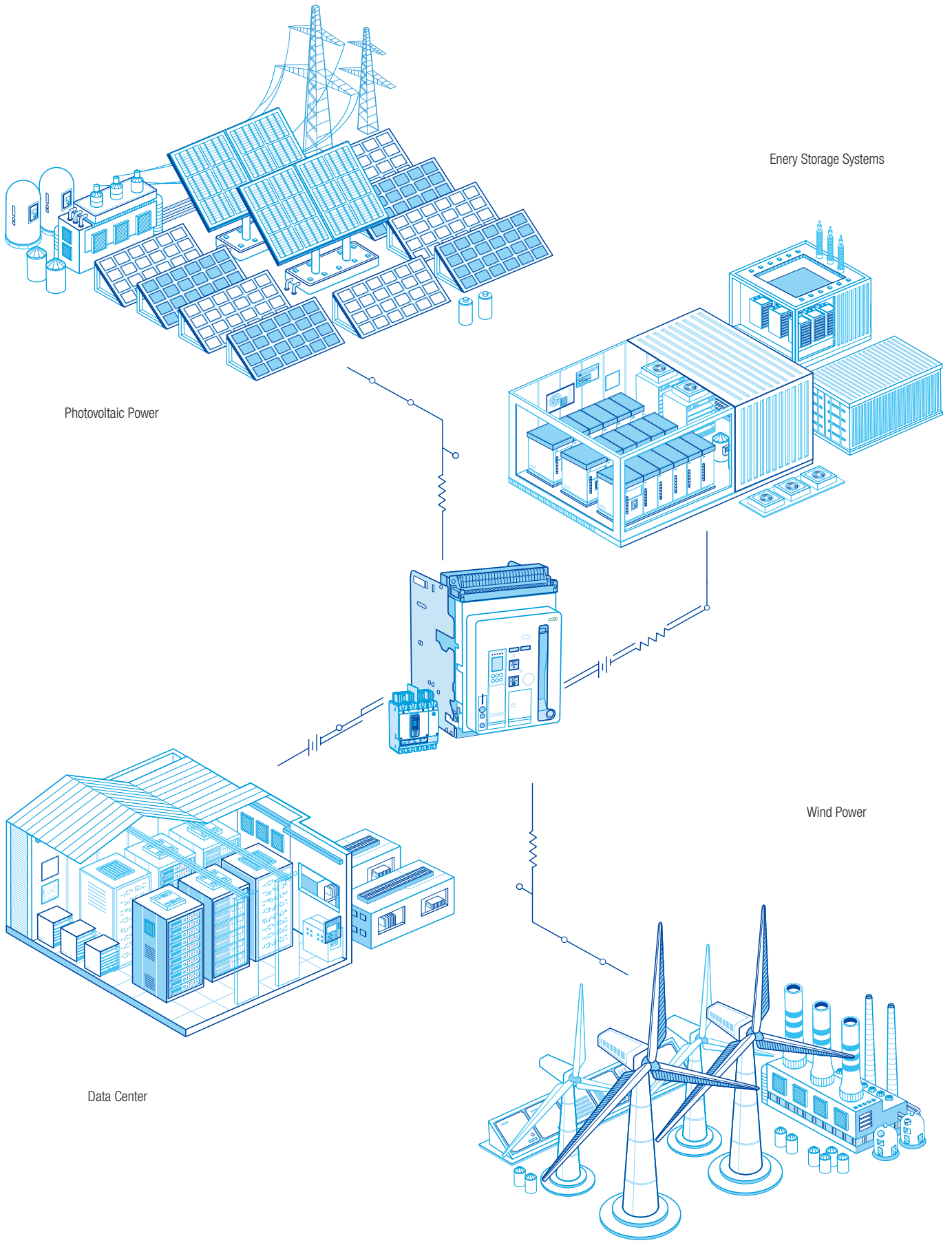

Photovoltaic Power

Energy Storage Systems

Data Center

Wind Power

# Green Energy Solutions



## High Voltage AC - Circuit Breakers

### Air Circuit Breaker

In accordance with the changing trend, ACB is equipped with various accessories and advanced level of digital protection relay. In addition, maximizes customer's range of selection and level of satisfaction with model dualization and compact size.

- Range 630 A - 4000 A
- No. of Poles : 3 Pole & 4 Pole
- Breaking Capacity 50 kA (at 1150 V)
- Rated operational voltage 1150 V
- Rated Impulse Withstand Voltage (Uimp) :12 kV
- BUS Bar Terminal can be changed to horizontal/vertical
- CB certification (UL), IEC 60947-1, 2
- CE Mark

**ZTRON** 



Frame	Rating	Pole	Rated Ultimate Short-Circuit Breaking Capacity [Icu] (kA rms) at 800V AC	Rated Ultimate Short-Circuit Breaking Capacity [Icu] (kA rms) at 1150V AC	Rated Service Short-Circuit Breaking Capacity [Ics] (...%×Icu)	Rated Short-Time withstand Current [Icw] (1s)	Per Unit LP (₹)
2000 A	630 A - 2000 A	3P & 4 P	75 kA	30 kA	100%	30 kA	POR
4000 A	630 A - 4000 A	3P & 4 P		50 kA	100%	50 kA	

### Moulded Case Circuit Breaker

- Range : 40 A - 630 A
- No. of Poles : 3 Pole & 4 Pole
- Breaking capacity : Ics = Icu = 100% upto 35 kA at 800 V AC  
Ics = Icu = 100% upto 20 kA 1000 V AC
- Rated operational voltage 1000 V AC & 800 V AC
- Rated Insulation Voltage Ui: 1000 V
- Rated Impulse Withstand Voltage Uimp: 8 kV
- Adjustable Thermal & Magnetic
- Field fittable accessories
- Conforms to IEC 60947-2

**QTRON** 



Frame	Rating	Pole	Rated Ultimate Short-Circuit Breaking Capacity [Icu] (kA rms) at 800V AC	Rated Ultimate Short-Circuit Breaking Capacity [Icu] (kA rms) at 1000V AC	Per Unit LP (₹)
100 A	40 A - 100 A	3P & 4 P	25 kA & 35 kA	15 kA & 20 kA	POR
160 A	100 A - 160 A	3P & 4 P			
250 A	125 A - 250 A	3P & 4 P			
400 A	300 A - 400 A	3P & 4 P			
630 A	500 A - 630 A	3P & 4 P			

## DC - Circuit Breakers

### Air Circuit Breaker



- Range 800 A - 4000 A
- Rated operational voltage 3 Pole - 1000 V DC  
4 Pole - 1500 V DC
- Rated Insulation Voltage  $U_i$  : 1000 V / 1500 V
- Rated Impulse Withstand Voltage  $U_{imp}$  : 12 kV
- IEC 60947-2 CB certification, IEC 60947-3 CB certification



Frame	Rating	Pole	Rated Ultimate Breaking Capacity [Icu]		Service Short-Circuit Breaking Capacity [Ics]	"Rated Short-Time Withstand Current [Icw] 1 Second		Per Unit LP (₹)
			3P at 1000 V DC	4P at 1500 V DC		3P at 1000 V DC	4P at 1500 V DC	
1600 A	800 A - 1600 A	3P & 4 P	60 kA		100%	50 kA	POR	
2500 A	1600 A - 2500 A	3P & 4 P						
3200 A	1600 A - 3200 A	3P & 4 P						
4000 A	2000 A - 4000 A	3P & 4 P						

### Moulded Case Circuit Breaker



- Range : 40 A - 800 A - DC 750 V for 3P & DC 1000 V for 4 Pole  
100 A - 630 A - DC 1500 V for 4 Pole
- Breaking capacity : Ics = Icu = 100% upto 100 kA at 1000 V DC  
Ics = Icu = 100% upto 50 kA 1500 V DC
- (Consistent performance across the entire frame)
- Rated Insulation Voltage  $U_i$ : 1000 V (at 1000 Vdc), 1500 V (at 1500 Vdc)
- Rated Impulse Withstand Voltage  $U_{imp}$ : 8 kV
- IEC60947-2, CB certification, DC 1000 V (MCCB 100 A / 160 A / 250 A / 630 A / 800 A)
- IEC 60947-2 Annex. P, CB certification



Frame	Rating	Pole	Rated Ultimate Short-Circuit Breaking Capacity [Icu] (kA rms) DC 1,500V for 4P (t=2ms)	Per Unit LP (₹)
100 A	100 A	4P	20 kA & 50 kA	POR
160 A	100 A - 160 A	4P		
250 A	160 A - 250 A	4P		
400 A	300 A - 400 A	4P		
630 A	500 A - 630 A	4P		

## Enclosure:

Cat Code	Description	Per Unit LP (₹)
IHAQ02500400	HI PAN - 250A QT2 I/C QT1 O/G TP 4W DD	67855.00
IHAQ02500800	HI PAN - 250A QT2 I/C QT1 O/G TP 8W DD	83025.00
IHAQ02501600	HI PAN - 250A QT2 I/C QT1 O/G TP 16W DD	118520.00
IHAQF2500400	HI PAN - 250A QT2 I/C QT1 O/G FP 4W DD	72015.00
IHAQF2500800	HI PAN - 250A QT2 I/C QT1 O/G FP 8W DD	90270.00
IHAQF2501200	HI PAN - 250A QT2 I/C QT1 O/G FP 12W DD	128865.00

## Prewired Meter Module:

Cat Code	Description	Per Unit LP (₹)
ISSBOU0706	Prewire Meter Module – Analog (Double Door)	24375.00
ISSBOU0707	Prewire Meter Module – Digital (Double Door)	30450.00

## Bare Meter Module / MCB Module / Add on Module:

Cat Code	Description	Per Unit LP (₹)
ISSBOU0703	Meter Module - Analog	10440.00
ISSBOU0704	MCB Module	
ISSBOU0705	Add on Module	

## Cable Alleys:

Cat Code	Description	Cable Alley Height (mm)	Per Unit LP (₹)
ISSBOU0691	CABLE ALLEY FOR O/G TP 2W/4W/6W DD	925	27640.00
ISSBOU0692	CABLE ALLEY FOR O/G TP 8W DD	1030	28985.00
ISSBOU0702	CABLE ALLEY FOR O/G TP 12W/16W DD	1445	40205.00
ISSBOU0691	CABLE ALLEY FOR O/G FP 2W/4W DD	925	27640.00
ISSBOU0692	CABLE ALLEY FOR O/G FP 6W/8W DD	1030	28985.00
ISSBOU0702	CABLE ALLEY FOR O/G FP 12W/16W DD	1445	40205.00

## POWERSAFE Enclosures

(Conforms to IEC:61439)

### 250 A Panel Board, OG TP A'Tron MCCB's

HSN Code: 85371000

Current Rating (A) Incomer	Outgoing* (No. of Ways)	(Double Door) Item Code	Per Unit LP (₹)
250 A "A" Frame MCCB Incomer	4	IHAT02500400	67855.00
	8	IHAT02500800	83025.00
	16	IHAT02501600	118520.00

### 250 A Panel Board, OG FP A'Tron MCCB's

HSN Code: 85371000

Current Rating (A) Incomer	Outgoing* (No. of Ways)	(Double Door) Item Code	Per Unit LP (₹)
250 A "A" Frame MCCB Incomer	4	IHATF2500400	72015.00
	8	IHATF2500800	90270.00
	12	IHATF2501200	128865.00



**Accessories**

HSN Code: 85371000

Description	Double Door Item Code	Per Unit LP (₹)
Cable Alley I/C 250 A, O/G 3P 2/4 Way	ISSBOU0690	20940.00
Cable Alley I/C 250 A,O/G 3P 6 Way & 4P 4 Way	ISSBOU0691	27640.00
Cable Alley I/C 250 A,O/G 3P 8 Way	ISSBOU0692	28985.00
Cable Alley I/C 250 A,O/G 4P 8 Way	ISSBOU0694	30990.00
Cable Alley I/C 250 A,O/G 3P 16 Way & 4P 12 Way	ISSBOU0696	36855.00

**Pre-Wired Meter Module with Voltmeter, Ammeter, Selector Switch, Ct's Control Fuse & Indicating Lights**

Description	Double Door Item Code	Per Unit LP (₹)
Prewire Meter Module - Analog	ISSBOU0706	24375.00
Meter Module - Digital	ISSBOU0707	30450.00

**Bare Meter Module / MCB Module / Add on Module**

Description	Double Door Item Code	Per Unit LP (₹)
"Meter Module - Analog Provision for Ammeter, Voltmeter - Analog with selector switch"	ISSBOU0703	10440.00
MCB Module	ISSBOU0704	
Add on Module	ISSBOU0705	

**Terminal for ATron Outgoing**

HSN Code: 85389000

Description	Item Code	Per Unit LP (₹)
Terminal for ATron Outgoing (Per Pole)	ISCCUPLTX012	185.00

**'G' Frame Panel Boards, O/G TP MCCBs G-Frame (10 kA)**

HSN Code: 85371000

Incomer**	Outgoing* (No. of Ways)	Double Door Item Code	Per Unit LP (₹)
250 A "AA" Frame MCCB	4	IHVG02500400	67855.00
	8	IHVG02500800	83025.00
	16	IHVG02501600	118520.00
400 A "LS" Frame MCCB	4	IHLG04000400	75355.00
	8	IHLG04000800	84590.00
	16	IHLG04001600	127155.00



\* The outgoing number of ways is the number of "G" Frame TP MCCBs that can be mounted. In case of SP MCCBs the number of MCCBs shall be three times the number of ways in TP MCCBs.

\*\* Maximum ratings are indicated for the incoming MCCBs however lower ratings in the same frame can be ordered. The above prices are for bare enclosures only, incoming and outgoing MCCBs have to be ordered separately.

**‘G’ Frame Panel Boards, O/G FP MCCBs G-Frame (10 kA)**

HSN Code: 85371000

Incomer**	Outgoing* (No. of Ways)	Double Door Item Code	Per Unit LP (₹)
250 A “AA” Frame MCCB	4	IHVGF2500400	72015.00
	8	IHVGF2500800	90270.00
	12	IHVGF2501200	128865.00
400 A “LS” Frame MCCB	4	IHLGF4000400	79955.00
	8	IHLGF4000800	91990.00
	12	IHLGF4001200	136950.00



\* The outgoing number of ways is the number of “G” Frame FP MCCBs that can be mounted. In case of SP MCCBs the number of MCCBs shall be four times the number of way in FP O/G MCCBs.

\*\* Maximum ratings are indicated for the incoming MCCBs however lower ratings in the same frame can be ordered. Outgoing spreader link for MCCB are available on request.

The above prices are for bare enclosures only, incoming and outgoing MCCBs have to be ordered separately.

**Accessories : Cable Alley for ‘G’ / ‘A’ Frame Panel Boards - Outgoing TP MCCB,**

Incomer ‘A’ & ‘L’ Frame MCCB

HSN Code: 85389000

Description*	Double Door Item Code	Per Unit LP (₹)
Cable Alley I/C 250 A,O/G 3P GF 2/4Way	ISSBOU0690	20940.00
Cable Alley I/C 250 A,O/G 3P GF 6WAY & 4P 2/4Way	ISSBOU0691	27640.00
Cable Alley I/C 250 A,O/G 3P GF 8WAY & 4P 6Way	ISSBOU0692	28985.00
Cable Alley I/C 250 A,O/G 4P GF 8Way	ISSBOU0694	30990.00
Cable Alley I/C 250 A,O/G 3P GF 16Way & 4P 12Way	ISSBOU0696	36855.00
Cable Alley I/C 400 A,O/G 3P GF 2/4Way	ISSBOU0697	23950.00
Cable Alley I/C 400 A,O/G 3P GF 6WAY & 4P 2/4Way	ISSBOU0698	23950.00
Cable Alley I/C 400 A/630 A, O/G 3P GF 8Way, 4P 6Way & A/F 6Way	ISSBOU0699	32585.00
Cable Alley I/C 400 A,O/G 3P GF 12Way	ISSBOU0700	36855.00
Cable Alley I/C 400 A/630 A, O/G 4P GF 8Way & TP A/F 8Way	ISSBOU0701	38535.00
Cable Alley I/C 400 A/630, O/G 4P GF 12Way, TP GF 16Way & TP A/F 12Way	ISSBOU0702	40205.00

\* Each set of Cable Alley consists of two numbers, one each on LHS and RHS.

**‘A’ Frame Panel Boards, O/G TP MCCBs**

HSN Code: 85371000

Incomer**	Outgoing* (No. of Ways)	Double Door Item Code	Per Unit LP (₹)
400 A “LS” Frame MCCB	8	IHLA04000800	112145.00
	12	IHLA04001200	143185.00
630 A “L” Frame MCCB	8	IHLA06300800	123250.00
	12	IHLA06301200	159345.00

\* The outgoing number of ways is the number of “A” Frame TP MCCBs that can be mounted.

\*\* Maximum ratings are indicated for the incoming MCCBs however lower ratings in the same frame can be ordered. Outgoing spreader link for MCCB are available on request.

The above prices are for bare enclosures only, incoming and outgoing MCCBs have to be ordered separately.

## Terminal for G & A Frame Outgoing

HSN Code: 85389000

Description	Item Code	Per Unit LP (₹)
Terminal for G Frame Outgoing (Per Pole)	ISCCUPBOP151	150.00
Terminal for A Frame Outgoing (Per Pole)	ISCCUPBOP167	390.00

## Pre-Wired Meter Module with Voltmeter, Ammeter, Selector Switch, Ct's Control Fuse & Indicating Lights

HSN Code: 85389000

Description	Double Door Item Code	Per Unit LP (₹)
Prewire Meter Module - Analog	ISSBOU0706	24375.00
Meter Module - Digital	ISSBOU0707	30450.00

## Bare Meter Module / MCB Module / Add on Module

HSN Code: 85389000

Description	Double Door Item Code	Per Unit LP (₹)
Meter Module - Analog Provision for Ammeter, Voltmeter - Analog with selector switch	ISSBOU0703	10440.00
MCB Module	ISSBOU0704	
Add on Module	ISSBOU0705	

Ammeter, Voltmeter, Selector Switch, Control Fuses, Indicating Lights, MCBs etc. have to be ordered separately and are at extra cost. The above prices are for bare module enclosures only.

## Add on Incoming Changeover Switch Enclosure only\*\*

\*\* The above prices are for bare module enclosures only.

HSN Code: 85389000

Description	Item Code	Per Unit LP (₹)
250 A Incoming change Over switch-F1	ISSBOU0708	16860.00
400 A & 630 A Incoming change Over switch - F2	ISSBOU0709	24780.00

## Add on Incoming Changeover Switch with Enclosure

HSN Code: 85389000

Description	Item Code	Per Unit LP (₹)
250 A Incoming change Over switch-F1	ISSBOU0712	67135.00
400 A Incoming change Over switch - F2	ISSBOU0713	88970.00
630 A Incoming change Over switch - F3	ISSBOU0714	99485.00

## Add on Incoming Automatic Changeover Switch with Enclosure

HSN Code: 85371000

Description	Item Code	Per Unit LP (₹)
100 A ATS FITT. ENCL P.SAFE	ISSBOU1128	178175.00
125 A ATS FITT. ENCL P.SAFE	ISSBOU1129	186525.00
250 A ATS FITT. ENCL P.SAFE	ISSBOU1126	259615.00

## Busbar Chambers - (Wall Mounted)

Busbar made of ETP Grade Copper

HSN Code: 85369030

Current Rating (A)	No. of	Item Code	Per Unit LP (₹)
63 A	4 WAY	IHBC006304 ▲	12850.00
100 A	4 WAY	IHBC010004 ▲	15410.00
200 A	4 WAY	IHBC020004 ▲	19285.00
250 A	4 WAY	IHBC025004 ▲	30115.00
315 A	4 WAY	IHBC031504 ▲	33350.00
400 A	4 WAY	IHBC040004 ▲	36030.00

▲ Stockable Item

For details on technical parameters & non stockable items contact nearest sales office.





HSN Code: 85365090

Open Enclosure			
Frame	Rating (A)	Catalogue Code	Per Unit LP (₹)
IS00 ▲	40 A	IHCCFO0040	7880.00
	63 A	IHCCFO0063	7880.00
	100 A	IHCCFO0100	10560.00
	125* A	IHCPFO0125	13485.00
IS02 ▲	125 A	IHCCFO0125	15775.00
	160 A	IHCCFO0160	16900.00
	200 A	IHCCFO0200	20270.00
	250* A	IHCPFO0250	22510.00
IS04 ▲	250 A	IHCCFO0250	29620.00
	315 A	IHCCFO0315	31285.00
	400* A	IHCPFO0400	34420.00
IS06 ▲	400 A	IHCCFO0400	45205.00
	630 A	IHCCFO0630	53715.00
	800* A	IHCPFO0800	61765.00

SS Enclosure Version			
Frame	Rating (A)	Catalogue Code	Per Unit LP (₹)
IS00	40 A	IHCCFE0040	11965.00
	63 A	IHCCFE0063 ▲	11965.00
	100 A	IHCCFE0100 ▲	15000.00
	125* A	IHCPFE0125 ▲	17810.00
IS02 ▲	125 A	IHCCFE0125	21960.00
	160 A	IHCCFE0160	23970.00
	200 A	IHCCFE0200	27335.00
	250* A	IHCPFE0250	29650.00
IS04 ▲	250 A	IHCCFE0250	38375.00
	315 A	IHCCFE0315	40045.00
	400* A	IHCPFE0400	43180.00
IS06 ▲	400 A	IHCCFE0400	60050.00
	630 A	IHCCFE0630	68550.00
	800* A	IHCPFE0800	76610.00

\*Compact Design (For AC 22 A application)

**Accessories**



Castell Lock



Auxiliary Switch



Direct Handle Conversion Kit

HSN Code: 85389000

Code	Item Description	Per Unit LP (₹)
ISSCNX0218	Castell Lock Frame IS00	3760.00
ISSCNX0217	Castell Lock Frame IS02 / IS04 / IS06	3760.00
ISCELQOX0074	Auxiliary Switch Assembly 2NO 2NC Frame IS00	920.00
ISCELQOX0076	Auxiliary Switch Assembly 2NO 2NC Frame IS02, IS04 & IS06	1205.00
ISSCNX0235	Direct Handle IS00	745.00
ISSCNX0221	Direct Handle IS02-IS04-IS06	2160.00
ISCCUPCNP179	Shorting Link IS00 Frame	845.00



HSN Code: 85371000

**INSTA**shift Motorised Changeover Switch

Open Enclosure			
Frame	Rating (A)	Catalogue Code	Per Unit LP (₹)
IS02	125 A	IHLFNAO125	65765.00
	160 A	IHLFNAO160 ▲	66985.00
	200 A	IHLFNAO200 ▲	70640.00
	250* A	IHLFNAO25D ▲	72835.00
IS04	250 A	IHLFNAO250 ▲	95675.00
	315 A	IHLFNAO315	97470.00
	400* A	IHLFNAO40D ▲	100845.00
IS06	400 A	IHLFNAO400 ▲	121560.00
	630 A	IHLFNAO630 ▲	130710.00
	800* A	IHLFNAO80D	139365.00

SS Enclosure Version			
Frame	Rating (A)	Catalogue Code	Per Unit LP (₹)
IS02	125 A	IHLFNAE125	77110.00
	160 A	IHLFNAE160	78335.00
	200 A	IHLFNAE200	82000.00
	250* A	IHLFNAE25D	84195.00
IS04	250 A	IHLFNAE250	108630.00
	315 A	IHLFNAE315	110425.00
	400* A	IHLFNAE40D	113790.00
IS06	400 A	IHLFNAE400	141880.00
	630 A	IHLFNAE630	151030.00
	800* A	IHLFNAE80D	159685.00

\*Compact Design (For AC 22 A application)

▲ Stockable Item  
For details on technical parameters & non stockable items contact nearest sales office.



**MTSE to RTSE Conversion Kit**



**RTSE Enclosure (with IP 43)\***

HSN Code: 85389000

	Code	Item Description	Per Unit LP (₹)
<b>MTSE to RTSE Conversion Kit</b>	ISSCNX0214	MOTOR MODULE FRAME IS02	49210.00
	ISSCNX0213	MOTOR MODULE FRAME IS04	64410.00
	ISSCNX0212	MOTOR MODULE FRAME IS06	73815.00
<b>RTSE Enclosure (with IP 32)</b>	ISSCNX0204	Enclosure Frame IS02	POR
	ISSCNX0205	Enclosure Frame IS04	
	ISSCNX0206	Enclosure Frame IS06	
<b>RTSE Enclosure (with IP 43)</b>	ISSCNX0256	Enclosure Frame IS02	POR
	ISSCNX0257	Enclosure Frame IS04	
	ISSCNX0258	Enclosure Frame IS06	

\*Available on request

**INSTA**shift Automatic Changeover Switch



With B Type Controller

HSN Code: 85371000

Open Enclosure			
Frame	Rating (A)	Catalogue Code	Per Unit LP (₹)
IS02	125 A	IHSFNAO125	80060.00
	160 A	IHSFNAO160	92055.00
	200 A	IHSFNAO200	98010.00
IS04	250 A	IHSFNAO250	113080.00
	315 A	IHSFNAO315	117110.00
IS06	400 A	IHSFNAO400	141720.00
	630 A	IHSFNAO630	164100.00

SS Enclosure Version			
Frame	Rating (A)	Catalogue Code	Per Unit LP (₹)
IS02	125 A	IHSFEBE125	93670.00
	160 A	IHSFEBE160	107705.00
	200 A	IHSFEBE200	114670.00
IS04	250 A	IHSFEBE250	132305.00
	315 A	IHSFEBE315	137020.00
IS06	400 A	IHSFEBE400	165810.00
	630 A	IHSFEBE630	191995.00

**INSTA**shift Automatic Changeover Switch



With M Type Controller

HSN Code: 85371000

Open Enclosure			
Frame	Rating (A)	Catalogue Code	Per Unit LP (₹)
IS02	125 A	IHPFNAO125	101720.00
	160 A	IHPFNAO160	113720.00
	200 A	IHPFNAO200	119670.00
IS04	250 A	IHPFNAO250	134745.00
	315 A	IHPFNAO315	138775.00
IS06	400 A	IHPFNAO400	163385.00
	630 A	IHPFNAO630	185765.00

SS Enclosure Version			
Frame	Rating (A)	Catalogue Code	Per Unit LP (₹)
IS02	125 A	IHPFEBE125	119010.00
	160 A	IHPFEBE160	133050.00
	200 A	IHPFEBE200	140015.00
IS04	250 A	IHPFEBE250	157650.00
	315 A	IHPFEBE315	162365.00
IS06	400 A	IHPFEBE400	191160.00
	630 A	IHPFEBE630	217345.00

HSN Code: 85389000

Code	Item Description	Per Unit LP (₹)
ISSCNX0350	IS02 Conversion Kit MTSE to ATSE B-TYPE	POR
ISSCNX0351	IS04 Conversion Kit MTSE to ATSE B-TYPE	
ISSCNX0352	IS06 Conversion Kit MTSE to ATSE B-TYPE	
ISSCNX0356	IS02 Conversion Kit RTSE to ATSE B-TYPE	
ISSCNX0357	IS04 Conversion Kit RTSE to ATSE B-TYPE	
ISSCNX0358	IS06 Conversion Kit RTSE to ATSE B-TYPE	
ISSCNX0353	IS02 Conversion Kit MTSE to ATSE M-TYPE	
ISSCNX0354	IS04 Conversion Kit MTSE to ATSE M-TYPE	
ISSCNX0355	IS06 Conversion Kit MTSE to ATSE M-TYPE	
ISSCNX0359	IS02 Conversion Kit RTSE to ATSE M-TYPE	
ISSCNX0360	IS04 Conversion Kit RTSE to ATSE M-TYPE	
ISSCNX0361	IS06 Conversion Kit RTSE to ATSE M-TYPE	
ISSCNX0199	M Type HMI	POR

**Enclosure for ATSE (with IP 32)**

HSN Code: 85389000

Code	Item Description	Per Unit LP (₹)
ISSCNX0267	ATSE Enclosure Frame IS02	POR
ISSCNX0268	ATSE Enclosure Frame IS04	
ISSCNX0269	ATSE Enclosure Frame IS06	

**Enclosure for ATSE (with IP 43)**

HSN Code: 85389000

Code	Item Description	Per Unit LP (₹)
ISSCNX0270	ATSE Enclosure Frame IS02	POR
ISSCNX0271	ATSE Enclosure Frame IS04	
ISSCNX0272	ATSE Enclosure Frame IS06	

**Front Fascia IP Kit**

HSN Code: 85389000

Code	Item Description	Per Unit LP (₹)
ISSCNX0233	RTSE / ATSE Front Fascia IP Kit	POR

**Door Extender Kit**

HSN Code: 85389000

Code	Item Description	Per Unit LP (₹)
ISSCNX0232	ATSE Door Extender Kit	POR



## Instaprime Automatic Transfer Switch ▲

Four Pole, AC-32B / AC - 33B\*, 50 Hz, 415 V  
Automatic/Manual Range

HSN Code: 85371000

Rating (A)	Open Execution Item Code	Per Unit LP (₹)	Cat. no. 4 pole (Close Execution)	Per Unit LP (₹)
63 A	IHRFBAO063	35820.00	IHRFBAE063	38710.00
100 A	IHRFBAO100	38880.00	IHRFBAE100	41750.00
125 A	IHRFBAO125	44040.00	IHRFBAE125	46905.00



\* In 63 A

## Instaline Automatic Transfer Switch ▲

Four Pole, AC-31A, 50 Hz, 415 V  
Automatic/Manual with complete protection

HSN Code: 85371000

Rating A	Item Code 4P	Per Unit LP (₹)	Item Code 4P	Per Unit LP (₹)
	Open Execution		With Enclosure	
100 A	IHYFCDO100	75890.00	IHYFCDE100	92745.00
125 A	IHYFCDO125	81420.00	IHYFCDE125	97470.00
160 A	IHYFCDO160	89860.00	IHYFCDE160	107195.00
200 A	IHYFCDO200	108570.00	IHYFCDE200	125085.00
250 A	IHYFCDO250	121765.00	IHYFCDE250	138765.00
315 A	IHYFCDO315	127290.00	IHYFCDE315	143805.00
400 A	IHYFCDO400	145715.00	IHYFCDE400	174470.00
630 A	IHYFCDO630	186990.00	IHYFCDE630	215170.00



## ATS Wire Harness

HSN Code: 85389000

Item Code	Per Unit LP (₹)
ISSYAX0201	4770.00

▲ Stockable Item

For details on technical parameters & non stockable items contact nearest sales office.

# Euroload (ON-Load) Changeover Switch (4 Pole) I-0-II

(Conforms to IS/IEC:60947-3)

HSN Code: 85365090

Frame Size	Rating (A)	Open Execution Item Code	Per Unit LP (₹)	SS Enclosure Item Code	Per Unit LP (₹)
00	040 A	IHCNFO0040	7960.00	IHCNFE0040	12175.00
00	063 A	IHCNFO0063 ▲	7960.00	IHCNFE0063 ▲	12175.00
00	100 A	IHCNFO0100 ▲	10665.00	IHCNFE0100 ▲	15270.00
0	125 A	IHCNFO0125 ▲	15925.00	IHCNFE0125 ▲	22365.00
0	160 A	IHCNFO0160 ▲	17055.00	IHCNFE0160 ▲	24405.00
0	200 A	IHCNFO0200 ▲	20460.00	IHCNFE0200 ▲	27830.00
1	250 A	IHCNFO0250 ▲	29895.00	IHCNFE0250 ▲	39070.00
1	320 A	IHCNFO0320 ▲	31580.00	IHCNFE0320 ▲	40770.00
2	400 A	IHCNFO0400 ▲	45640.00	IHCNFE0400 ▲	61140.00
2	630 A	IHCNFO0630 ▲	54755.00	IHCNFE0630 ▲	70475.00
3	800 A	IHCNFO0800 ▲	81180.00	IHCNFE0800 ▲	104995.00
4	1000 A	IHCNFO1000 ▲	140915.00	IHCNFE1000 ▲	195045.00
4	1250 A	IHCNFO1250 ▲	187085.00	IHCNFE1250 ▲	261115.00
4	1600 A	IHCNFO1600 ▲	222810.00	IHCNFE1600 ▲	350645.00
5	2000 A	IHCNFO2000	358220.00	IHCNFE2000	479445.00
5	2500 A	IHCNFO2500	475110.00	IHCNFE2500	612100.00
5	3150 A	IHCNFO3150	650460.00	IHCNFE3150	829240.00



Note :  
Phase Barriers & Handle with door interlock kit is integral part of the Changeover Switch.  
Aux. contacts for signalling and electrical interlocking are optional and provided at extra price.

## Euroload By Pass Switch

Conforms to IS:13947 (Part-3); IEC:60947-3

Four Pole, 415 V

HSN Code: 85365090

Frame Size	Current Rating (A)	Open Execution Item Code	Per Unit LP (₹)
00	063 A	IHCBFO0063 ▲	14410.00
00	100 A	IHCBFO0100 ▲	16995.00
0	125 A	IHCBFO0125 ▲	21655.00
0	160 A	IHCBFO0160 ▲	25790.00
0	200 A	IHCBFO0200 ▲	27740.00
1	250 A	IHCBFO0250 ▲	40910.00
1	320 A	IHCBFO0320 ▲	43220.00
2	400 A	IHCBFO0400 ▲	62475.00
2	630 A	IHCBFO0630 ▲	74215.00
3	800 A	IHCBFO0800 ▲	111090.00
3	1000 A	IHCBFO1000 ▲	198200.00
3	1600 A	IHCBFO1600 ▲	313395.00

## Accessories

HSN Code: 85389000

Aux. Contact	Item Code	Per Unit LP (₹)
1 NO. 1 NC.	IHCNFAC1CO	550.00
2 NO. 2 NC.	IHCNFAC2CO	745.00



▲ Stockable Item  
For details on technical parameters & non stockable items contact nearest sales office.

Effective from 1st April, 2026

List Price (LP) are in Indian ₹ & as per Standard Terms & Conditions **HAVELLS** 43

## Euroload Switch Disconnecter

(Conforms to IS/IEC:60947-3)

Three Pole, 415 V

HSN Code: 85365090

Frame Size	Current Rating A	Open Execution Item Code	Per Unit LP (₹)	SS Enclosure Item Code	Per Unit LP (₹)
0	80 A	IHCSTO0080	2710.00	IHCSTE0080	4215.00
0	100 A	IHCSTO0100	4105.00	IHCSTE0100	5830.00
0	125 A	IHCSTO0125	5460.00	IHCSTE0125	7090.00
0	160 A	IHCSTO0160	6495.00	IHCSTE0160	8965.00
0	200 A	IHCSTO0200	7390.00	IHCSTE0200	9150.00
1	250 A	IHCSTO0250	9315.00	IHCSTE0250	11865.00
1	320 A	IHCSTO0320 ▲	10230.00	IHCSTE0320	13015.00
1	400 A	IHCSTO0400 ▲	14740.00	IHCSTE0400	17750.00



## Euroload Switch Disconnecter

Four Pole, 415 V

HSN Code: 85365090

Frame Size	Current Rating A	Open Execution Item Code	Per Unit LP (₹)	SS Enclosure Item Code	Per Unit LP (₹)
00	40 A	IHCSFO0040	1985.00	IHCSFE0040	3250.00
00	63 A	IHCSFO0063	2240.00	IHCSFE0063	3550.00
00	100 A	IHCSFO0100	5345.00	IHCSFE0100	6535.00
0	125 A	IHCSFO0125	5695.00	IHCSFE0125	7205.00
0	160 A	IHCSFO0160 ▲	6820.00	IHCSFE0160	8325.00
0	200 A	IHCSFO0200 ▲	8235.00	IHCSFE0200	9940.00
1	250 A	IHCSFO0250 ▲	10410.00	IHCSFE0250	13505.00
1	320 A	IHCSFO0320	11425.00	IHCSFE0320	14340.00
2	400 A	IHCSFO0400 ▲	15840.00	IHCSFE0400	19795.00
2	630 A	IHCSFO0630 ▲	18310.00	IHCSFE0630	22565.00
3	800 A	IHCSFO0800 ▲	27295.00	IHCSFE0800	32195.00
4	1000 A	IHCSFO1000 ▲	41295.00	IHCSFE1000	58500.00
4	1250 A	IHCSFO1250 ▲	62020.00	IHCSFE1250	70375.00
4	1600 A	IHCSFO1600 ▲	85345.00	IHCSFE1600	94630.00
5	2000 A	IHCSFO2000	97805.00	IHCSFE2000	124585.00
5	2500 A	IHCSFO2500	126920.00	IHCSFE2500	163080.00
5	3150 A	IHCSFO3150	179030.00	IHCSFE3150	231770.00



▲ Stockable Item

For details on technical parameters & non stockable items contact nearest sales office.

# Kompact *plus* Switch Disconnecter Fuse

(Conforms to IS/IEC:60947- Part 1 & 3)

Switch Disconnecter Fuse (Panel Mounting Cubicle Type) - AC-23 A, 50 Hz, 415 V  
Kompact Plus



HSN Code: 85371000

Rating A	Pole	Type of Fuse	With / Without Fuse	Item Code	Per Unit LP (₹)	Item Code	Per Unit LP (₹)	Suitable Fuse
				Open Execution		In Sheet Steel Encl.		
32 A	TPN	Bolted Type	With 3 Fuses	IHKDTF4032 ▲	3620.00	IHKDTW4032 ▲	5830.00	IHHTIA0032
63 A				IHKDTF4063 ▲	4980.00	IHKDTW4063 ▲	7210.00	IHHTSS0063
100 A				IHKDTF4100 ▲	10080.00	IHKDTW4100 ▲	12175.00	IHHTSD0100
125 A				IHKDTF4125 ▲	12775.00	IHKDTW4125 ▲	14960.00	IHHTSD0125
32 A		Bolted Type	Without Fuse	IHKDTO4032 ▲	3150.00	IHKDTE4032	5360.00	IHHTIA0032
63 A				IHKDTO4063	4405.00	IHKDTE4063	6640.00	IHHTSS0063
100 A				IHKDTO4100 ▲	8895.00	IHKDTE4100	10995.00	IHHTSD0100
125 A				IHKDTO4125	11595.00	IHKDTE4125	13780.00	IHHTSD0125
32 A	FP	Bolted Type	With 4 Fuses	IHKDFF4032	4940.00	IHKDFW4032	7305.00	IHHTIA0032
63 A				IHKDFF4063	6305.00	IHKDFW4063	8680.00	IHHTSS0063
100 A				IHKDFF4100	12645.00	IHKDFW4100	15025.00	IHHTSD0100
125 A				IHKDFF4125	15250.00	IHKDFW4125	17715.00	IHHTSD0125
32 A		Bolted Type	Without Fuse	IHKDFO4032	4325.00	IHKDFE4032	6690.00	IHHTIA0032
63 A				IHKDFO4063	5540.00	IHKDFE4063	7910.00	IHHTSS0063
100 A				IHKDFO4100	11050.00	IHKDFE4100	13435.00	IHHTSD0100
125 A				IHKDFO4125	13665.00	IHKDFE4125	16145.00	IHHTSD0125
32 A	TPN	DIN Type	With 3 Fuses	IHKFTF4032	5155.00	IHKFTW4032	6895.00	IHHCD00032
63 A				IHKFTF4063 ▲	6555.00	IHKFTW4063 ▲	8485.00	IHHCD00063
100 A				IHKFTF4100	11215.00	IHKFTW4100 ▲	13380.00	IHHCD00100
125 A				IHKFTF4125 ▲	14200.00	IHKFTW4125 ▲	16375.00	IHHCD00125
32 A		DIN Type	Without Fuse	IHKFTO4032 ▲	3405.00	IHKFTE4032	5145.00	IHHCD00032
63 A				IHKFTO4063	4740.00	IHKFTE4063	6670.00	IHHCD00063
100 A				IHKFTO4100	9220.00	IHKFTE4100	11390.00	IHHCD00100
125 A				IHKFTO4125	12180.00	IHKFTE4125	14365.00	IHHCD00125
32 A	FP	DIN Type	With 4 Fuses	IHKFFF4032	7015.00	IHKFFW4032	8870.00	IHHCD00032
63 A				IHKFFF4063	8475.00	IHKFFW4063	10500.00	IHHCD00063
100 A				IHKFFF4100	14505.00	IHKFFW4100	16795.00	IHHCD00100
125 A				IHKFFF4125	15900.00	IHKFFW4125	18140.00	IHHCD00125
32 A		DIN Type	Without Fuse	IHKFFO4032	4675.00	IHKFFE4032	6530.00	IHHCD00032
63 A				IHKFFO4063	6050.00	IHKFFE4063	8085.00	IHHCD00063
100 A				IHKFFO4100	11855.00	IHKFFE4100	14150.00	IHHCD00100
125 A				IHKFFO4125	13210.00	IHKFFE4125	15455.00	IHHCD00125

▲ Stockable Item

For details on technical parameters & non stockable items contact nearest sales office.

# Kompact *plus* Switch Disconnecter Fuse Unit

(Conforms to IS/IEC:60947- Part 1 & 3)

Switch Disconnecter Fuse (Panel Mounting Cubicle Type) - AC-23 A, 50 Hz, 415 V  
Kompact EZO



TPN

HSN Code: 85371000

Rating A	Pole	Type of Fuse		Item Code	Per Unit LP (₹)	Item Code	Per Unit LP (₹)	Suitable Fuse		
				Open Execution		In Sheet Steel Encl.				
160 A	TPN	Bolted Type	With 3 Fuses	IHFSTF4160 ▲	14530.00	IHFSTW4160 ▲	18755.00	IHHTSF0160		
200 A				IHFSTF4200 ▲	18900.00	IHFSTW4200 ▲	23030.00	IHHTSF0200		
250 A				IHFSTF4250 ▲	22255.00	IHFSTW4250 ▲	26240.00	IHHTSF0250		
320 A				IHFSTF4320 ▲	27400.00	IHFSTW4320 ▲	32110.00	IHHTSK0315		
400 A				IHFSTF4400 ▲	34590.00	IHFSTW4400 ▲	39060.00	IHHTSMF400		
630 A				IHFSTF4630 ▲	57805.00	IHFSTW4630 ▲	62355.00	IHHTLM0630		
800 A				IHFSTF4800	68300.00	IHFSTW4800 ▲	72785.00	IHHTLM0800		
160 A				Bolted Type	Without Fuse	IHFSTO4160	12690.00	IHFSTE4160	16920.00	IHHTSF0160
200 A		IHFSTO4200	17035.00			IHFSTE4200	21170.00	IHHTSF0200		
250 A		IHFSTO4250	20245.00			IHFSTE4250	24235.00	IHHTSF0250		
320 A		IHFSTO4320	24790.00			IHFSTE4320	29505.00	IHHTSK0315		
400 A		IHFSTO4400	29700.00			IHFSTE4400	34160.00	IHHTSMF400		
630 A		IHFSTO4630	47875.00			IHFSTE4630	52405.00	IHHTLM0630		
800 A		IHFSTO4800	57105.00			IHFSTE4800	61590.00	IHHTLM0800		
160 A		DIN Type	With 3 Fuses			IHFKTF4160	16060.00	IHFKTW4160 ▲	19955.00	IHHCD01160
200 A				IHFKTF4200 ▲	19605.00	IHFKTW4200 ▲	24390.00	IHHCD01200		
250 A				IHFKTF4250 ▲	22990.00	IHFKTW4250 ▲	27510.00	IHHCD01250		
320 A				IHFKTF4320 ▲	28780.00	IHFKTW4320 ▲	33185.00	IHHCD02315		
400 A				IHFKTF4400 ▲	34225.00	IHFKTW4400 ▲	38615.00	IHHCD02400		
630 A				IHFKTF4630 ▲	54960.00	IHFKTW4630 ▲	59660.00	IHHCD03630		
160 A				DIN Type	Without Fuse	IHFKTO4160	13115.00	IHFKTE4160	17005.00	IHHCD01160
200 A						IHFKTO4200	16675.00	IHFKTE4200	21445.00	IHHCD01200
250 A		IHFKTO4250	19670.00			IHFKTE4250	24195.00	IHHCD01250		
320 A		IHFKTO4320	24475.00			IHFKTE4320	28870.00	IHHCD02315		
400 A	IHFKTO4400	29595.00	IHFKTE4400			33970.00	IHHCD02400			
630 A	IHFKTO4630	47655.00	IHFKTE4630			52370.00	IHHCD03630			
800 A	IHFKTO4800	52190.00	IHFKTE4800			58155.00	IHHCD03800			

▲ Stockable Item

For details on technical parameters & non stockable items contact nearest sales office.

# Kompact *plus* Switch Disconnecter Fuse

(Conforms to IS/IEC:60947- Part 1 & 3)

Four Pole

HSN Code: 85371000

Rating A	Pole	Type of Fuse		Item Code	Per Unit LP (₹)	Item Code	Per Unit LP (₹)	Suitable Fuse
				Open Execution		In Sheet Steel Encl.		
160 A	FP	Bolted Type	With 4 Fuses	IHFSFF4160	19920.00	IHFSFW4160	23985.00	IHHTSF0160
200 A				IHFSFF4200	23410.00	IHFSFW4200	27255.00	IHHTSF0200
250 A				IHFSFF4250	26835.00	IHFSFW4250	30525.00	IHHTSF0250
320 A				IHFSFF4320	31000.00	IHFSFW4320	35210.00	IHHTSK0315
400 A				IHFSFF4400	38060.00	IHFSFW4400	42955.00	IHHTSMF400
630 A				IHFSFF4630	63600.00	IHFSFW4630	68590.00	IHHTLM0630
800 A				IHFSFF4800	75125.00	IHFSFW4800	80060.00	IHHTLM0800
160 A		Bolted Type	Without Fuse	IHFSFO4160	17475.00	IHFSFE4160	21550.00	IHHTSF0160
200 A				IHFSFO4200	20940.00	IHFSFE4200	24790.00	IHHTSF0200
250 A				IHFSFO4250	24150.00	IHFSFE4250	27850.00	IHHTSF0250
320 A				IHFSFO4320	27525.00	IHFSFE4320	32450.00	IHHTSK0315
400 A				IHFSFO4400	32670.00	IHFSFE4400	37580.00	IHHTSMF400
630 A				IHFSFO4630	52650.00	IHFSFE4630	57640.00	IHHTLM0630
800 A				IHFSFO4800	62820.00	IHFSFE4800	67750.00	IHHTLM0800
160 A		DIN Type	With 4 Fuses	IHFKFF4160	18945.00	IHFKFW4160	22565.00	IHHCD01160
200 A				IHFKFF4200	23850.00	IHFKFW4200	27490.00	IHHCD01200
250 A				IHFKFF4250	25295.00	IHFKFW4250	30250.00	IHHCD01250
320 A				IHFKFF4320	31660.00	IHFKFW4320	36510.00	IHHCD02315
400 A				IHFKFF4400	37660.00	IHFKFW4400	42465.00	IHHCD02400
630 A				IHFKFF4630	63960.00	IHFKFW4630	68200.00	IHHCD03630
800 A				IHFKFF4800	75125.00	IHFKFW4800	80060.00	IHHCD03800
160 A		DIN Type	Without Fuse	IHFKFO4160	15010.00	IHFKFE4160	18650.00	IHHCD01160
200 A				IHFKFO4200	19930.00	IHFKFE4200	23570.00	IHHCD01200
250 A				IHFKFO4250	21640.00	IHFKFE4250	26605.00	IHHCD01250
320 A	IHFKFO4320			26925.00	IHFKFE4320	31775.00	IHHCD02315	
400 A	IHFKFO4400			32560.00	IHFKFE4400	37370.00	IHHCD02400	
630 A	IHFKFO4630			54230.00	IHFKFE4630	58465.00	IHHCD03630	
800 A	IHFKFO4800			63370.00	IHFKFE4800	69275.00	IHHCD03800	

## Accessories

HSN Code: 85389000

Cat Code	Description	Per Unit LP (₹)
ISSCBX0001	1 NO-NC SWITCH FOR SDF (32A-125A)	780.00
ISSCBX0002	1 NO-NC SWITCH FOR SDF (160A-800A)	930.00
ISSCBX0003	2 NO-NC SWITCH FOR SDF (32A-125A)	1405.00
ISSCBX0004	2 NO-NC SWITCH FOR SDF 160A-800A)	1550.00

▲ Stockable Item

For details on technical parameters & non stockable items contact nearest sales office.

# HiBreak HBC Fuse Link

(Conforms to IS: 13703-1 & 2-1 / IEC:60269-1 & 2-1)

## DIN Fuse Bases (Fixed Type)

Specification: IEC: 60269-1 & 2-1 / IS: 13703-1 & 2-1.

HSN Code: 85361020

Rated A	Item Code	Type	Fuse Type	Per Unit LP (₹)	STD Packing No. of unit/s
160 A	IHUC00O160 ▲	Open Type Fuse Base	CD-00	595.00	6 N



## i Base - DIN Fuse Bases (Fixed Type)

Specification: IEC: 60269-1 & 2-1 / IS: 13703-1 & 2-1.

HSN Code: 85361020

Rated A	Item Code	Type	Fuse Type	Per Unit LP (₹)	STD Packing No. of unit/s
250 A	IHIC01O250 ▲	Open Type Fuse Base	CD-1	1185.00	3 N
400 A	IHIC02O400 ▲	Open Type Fuse Base	CD-2	1905.00	3 N
630 A	IHIC03O630 ▲	Open Type Fuse Base	CD-3	2215.00	3 N
800 A	IHIC03O800	Open Type Fuse Base	CD-3	2215.00	3 N



▲ Stockable Item

For details on technical parameters & non stockable items contact nearest sales office.

# HiBreak HBC Fuse Link

(Conforms to IS: 13703-1 & 2-1 / IEC:60269-1 & 2-1)



## Bolted Type HRC Fuse - 80 kA, 415 V

IS Size	Tag Type	BS Type	Rating (A)	Item Code	Per Unit LP (₹)	STD Packing No. of unit/s
<b>HSN Code: 85361010</b>						
F-1	Offset	NS	2 A	IHHNS00002	100.00	20 N
			4 A	IHHNS00004		
			6 A	IHHNS00006		
			10 A	IHHNS00010 ▲		
<b>HSN Code: 85361020</b>						
F-1	Offset	NS	16 A	IHHNS00016	100.00	20 N
			20 A	IHHNS00020	110.00	
			25 A	IHHNS00025		
			32 A	IHHNS00032		
A-2	Offset	TIA	16 A	IHHTIA0016	140.00	10 N
			20 A	IHHTIA0020		
			25 A	IHHTIA0025		
			32 A	IHHTIA0032 ▲		
A-3	Offset	TSS	40 A	IHHTSS0040	170.00	10 N
			50 A	IHHTSS0050		
			63 A	IHHTSS0063 ▲		
A-4	Offset	TSD	80 A	IHHTSD0080	375.00	10 N
			100 A	IHHTSD0100 ▲		
			125 A	IHHTSD0125 ▲		
B-1	Central	TSDC	80 A	IHHTSDC080	380.00	10 N
			100 A	IHHTSDC100		
			125 A	IHHTSDC125		
B-2	Central	TSF	160 A	IHHTSF0160	550.00	10 N
			200 A	IHHTSF0200 ▲	595.00	
			250 A	IHHTSF0250 ▲		
B-3	Central	TSK	315 A	IHHTSK0315 ▲	780.00	3 N
B - 4	Central	TSMF	400 A	IHHTSMF400 ▲	1465.00	3 N
C - 1	Central	TSMS	400 A	IHHTSMS400		3 N
C - 2	Central	TTS	400 A	IHHTTS0400	1670.00	1 N
C - 2	Central	TLM	630 A	IHHTLM0630 ▲	2975.00	1 N
C - 2	Central	TLM	800 A	IHHTLM0800	3315.00	1 N

▲ Stockable Item

For details on technical parameters & non stockable items contact nearest sales office.

## DIN Type HRC Fuse - 80 kA, 415 V

IS Size	Rating (A)	Item Code	Per Unit LP (₹)	STD Packing No. of unit/s		
<b>HSN Code: 85361020</b>						
000	32 A	IHHCD11032	460.00	3 N		
	63 A	IHHCD11063	475.00			
	100 A	IHHCD11100	505.00			
<b>HSN Code: 85361010</b>						
00	6 A	IHHCD00006	515.00	3 N		
	10 A	IHHCD00010				
<b>HSN Code: 85361020</b>						
00	16 A	IHHCD00016	515.00	3 N		
	25 A	IHHCD00025 ▲				
	32 A	IHHCD00032 ▲				
	40 A	IHHCD00040 ▲	540.00			
	50 A	IHHCD00050				
	63 A	IHHCD00063 ▲				
	80 A	IHHCD00080	595.00			
	100 A	IHHCD00100 ▲				
	125 A	IHHCD00125 ▲				
	160 A	IHHCD00160 ▲	640.00			
	01	100 A	IHHCD01100 ▲		870.00	3 N
		125 A	IHHCD01125			
160 A		IHHCD01160 ▲	880.00			
200 A		IHHCD01200 ▲				
250 A		IHHCD01250 ▲	985.00			
02	250 A	IHHCD02250	1275.00	1 N		
	315 A	IHHCD02315 ▲				
	350 A	IHHCD02350	1370.00			
	400 A	IHHCD02400 ▲				
03	500 A	IHHCD03500 ▲	2105.00	1 N		
	630 A	IHHCD03630 ▲	2155.00			
	800 A	IHHCD03800	2660.00			



# HGS - Trusted Global Range

## Contactors, Overload Relays & MPCBs

Motor Control Solutions for higher Safety, Reliability & Performance



HGS - 3 Pole Contactor  
Ratings - 9 A to 800 A (AC-3)



HGS - 4 Pole Contactor  
Ratings - 16 A to 60 A (AC-1)



HGS - 2 Pole Contactor  
Ratings - 9 A to 100 A (AC-3)



HGST - Thermal Overload Relay  
Ratings - 0.12 A to 800 A



Capacitor Duty Contactor  
Ratings - 3 kVAr to 66 kVAr



HGS - R Contactor  
Ratings - 9 A to 100 A



Motor Protection  
Circuit Breaker  
Ratings - 0.1 A to 32 A



Motor Protection  
Circuit Breaker  
Ratings - 0.1 A to 63 A

# Contactor HGS 9 - 800 AF

- 3 Pole Power Contactors
- Wide band Operating Coils
- Finger proof IP 20 terminals
- Suitable for AC-4 (Inching & Plugging, e.g. Crane Duty) and other critical application
- CE Marking & Compliance to IS/IEC 60947-4-1
- High Electrical and Mechanical Durability with Higher operating frequency (Operations / Hour)
- Electrical Durability Curves available
- Low VA Burden coils with Class H Insulation
- Dust free covers
- Terminal Barrier and Shrouds
- In-built Auxiliary Contacts
- DIN Channel Mounting upto 100 A (Frame 1 to 4)

## Contactor (HGS)



## Overload Relay (HGST)



18 AF

40 AF

65 AF

100 AF

HGS  
Rated Current  
Rated Operational  
Voltage

9 A, 12 A, 18 A, 22 A  
690 V

25 A, 32 A, 40 A  
690 V

50 A, 65 A  
690 V

75 A, 85 A, 100 A  
690 V

HGST  
Setting Current

0.12 A - 18 A

7 A - 40 A

7 A - 65 A

17 A - 100 A

# Thermal Overload Relays HGST 9 - 800 AF

- Overload Relays
- Trip Class - 10 A
- Automatic Reset / Manual Reset
- Test Button for emergency stop
- Phase loss Protection
- Accelerated tripping on single phasing condition
- IP20 terminals
- Sealable Protection Cover



**150 AF**

**265 AF**

**500 AF**

**800 AF**

115 A, 130 A, 150 A  
1000 V

185 A, 225 A, 265 A  
1000 V

300 A, 400 A, 500 A  
1000 V

630 A, 800 A  
1000 V

48 A - 150 A

48 A - 265 A

90 A - 500 A

378 A - 800 A

# Magnetic Contactor

## 3 Pole Power Contactors



### Features:

- AC Coil up to Frame-4 and AC/DC Universal coil with SMART ECM (Electronic Control Module) in-built for Frame-5 to Frame-8
- Conforms to IS / IEC 60947-4-1
- Finger proof IP20 terminals
- Low VA Burden Wide operating band coils with Class H Insulation

HSN Code: 85369090

Frame Size	AC-3 Duty Rating at 415 V, 50 Hz	AC-1 Duty Rating at 415 V, 50 Hz	Power Poles	In-built Auxilliary Contacts		Type	Item Code	Per Unit LP (₹)
	I <sub>e</sub> A	I <sub>th</sub> A		NO	NC			
1	9 A ▲	25 A	3	1	0	HGS 9	IHPHA009110*	1707.00
	9 A ▲	25 A	3	0	1	HGS 9	IHPHA009101*	1707.00
	12 A ▲	25 A	3	1	0	HGS 12	IHPHA012110*	1988.00
	12 A ▲	25 A	3	0	1	HGS 12	IHPHA012101*	1988.00
	18 A ▲	40 A	3	1	0	HGS 18	IHPHA018110*	2295.00
	18 A ▲	40 A	3	0	1	HGS 18	IHPHA018101*	2295.00
	22 A ▲	40 A	3	1	0	HGS 22	IHPHA022110*	2479.00
2	22 A	40 A	3	0	1	HGS 22	IHPHA022101*	2479.00
	25 A ▲	45 A	3	1	0	HGS 25	IHPHA025210*	3197.00
	25 A ▲	45 A	3	0	1	HGS 25	IHPHA025201*	3197.00
	32 A ▲	55 A	3	1	0	HGS 32	IHPHA032210*	6081.00
	32 A ▲	55 A	3	0	1	HGS 32	IHPHA032201*	6081.00
	40 A ▲	60 A	3	1	0	HGS 40	IHPHA040210*	9056.00
3	40 A ▲	60 A	3	0	1	HGS 40	IHPHA040201*	9056.00
	50 A ▲	70 A	3	2	2	HGS 50	IHPHA050300*	12231.00
4	65 A ▲	85 A	3	2	2	HGS 65	IHPHA065300*	15315.00
	75 A ▲	110 A	3	2	2	HGS 75	IHPHA075400*	18333.00
	85 A ▲	125 A	3	2	2	HGS 85	IHPHA085400*	21606.00
5	100 A ▲	135 A	3	2	2	HGS 100	IHPHA100400*	31148.00
	115 A	160 A	3	2	2	HGS 115	IHPHA115500*	38394.00
	130 A	180 A	3	2	2	HGS 130	IHPHA130500*	39528.00
6	150 A	210 A	3	2	2	HGS 150	IHPHA150500*	48174.00
	185 A	275 A	3	2	2	HGS 185	IHPHA185600*	55718.00
	225 A	315 A	3	2	2	HGS 225	IHPHA225600*	60556.00
7	265 A	350 A	3	2	2	HGS 265	IHPHA265600*	68165.00
	300 A	400 A	3	2	2	HGS 300	IHPHA300700*	83711.00
8	400 A	500 A	3	2	2	HGS 400	IHPHA400700*	104674.00
	500 A	550 A	3	2	2	HGS 500	IHPHA500700*	150779.00
	630 A	750 A	3	2	2	HGS 630	IHPHA630800*	235224.00
8	800 A	900 A	3	2	2	HGS 800	IHPHA800800*	379518.00

### Coil Voltage Selection Table

\*To complete the Item Code suffix the coil voltage from the coil voltage table  
 Note: 1. For additional aux. contacts front/side mounted and mechanical interlock - refer accessories table on page no. 54  
 2. Standard Spare coil are available on request on page no 54

ECM\* - Electronic Control Module  
 Note : For other coil voltages, Contact to nearest branch  
 To avoid Coil burning due to Neutral Floaring conditions, either use Wide band Coils or make use of 415 V Coils

Frame Size	AC Coil Codes for Nominal Voltage at 50/60 Hz			
	H	N	Wide Band Coils	
			S	W
1	110 V		150 V - 300 V ▲	260 V - 440 V ▲
2	110 V		150 V - 300 V ▲	260 V - 440 V ▲
3	110 V	180 V - 280 V		260 V - 440 V ▲
4	110 V	180 V - 280 V		260 V - 440 V ▲
	AC/DC Universal Coil with in-built ECM* Module 240 V N		AC Coil Y	AC Coil T
5, 6, 7	100 V AC -240 V AC & 110 V DC -220 V DC		240 V AC	415 V AC
8	200 V AC -240 V AC & 200 V DC -220 V DC		240 V AC	415 V AC

▲ Stockable Item

For details on technical parameters & non stockable items contact nearest sales office.

# Magnetic Contactor

## 4 Pole Power Contactors with AC Coil



### Features:

- AC-1 Ratings up to 60 A
- Conforms to IS / IEC 60947-4-1
- Common Accessories with HGS Range
- Finger proof IP20 terminals
- Completely Shield for dusty atmosphere
- Low VA Burden Wide operating band coils with Class H Insulation

HSN Code: 85369090

Frame Size	AC 1 Duty	Power Poles	Item Code	Per Unit LP (₹)	Power Poles	Item Code	Per Unit LP (₹)
1	16 A	4NO	IHPHC016100*	1885.00	2NO + 2NC	IHPHC016122*	2247.00
	20 A	4NO	IHPHC020100*	1935.00	2NO + 2NC	IHPHC020122*	2295.00
	25 A	4NO	IHPHC025100*	2090.00	2NO + 2NC	IHPHC025122*	2555.00
	32 A ▲	4NO	IHPHC032100*	2140.00	2NO + 2NC	IHPHC032122*	2646.00
	40 A	4NO	IHPHC040100*	3225.00	2NO + 2NC	IHPHC040122*	3759.00
2	50 A	4NO	IHPHC050200*	4210.00	2NO + 2NC	IHPHC050222*	5098.00
	60 A ▲	4NO	IHPHC060200*	8025.00	2NO + 2NC	IHPHC060222*	9720.00

\*To complete the Item Code suffix the coil voltage from the coil voltage table  
Note: Coil S & W is not available for - 2 NO + 2 NC

# Magnetic Contactor

## Aux Contactor / Control Relay - HGS Series with AC Coil

### Features:

- Common Accessories with HGS Range
- Suitable for use upto 690 V AC
- Compliance to IEC 60947-5-1
- High Thermal current of  $I_{th} = 16 A$
- Finger proof IP20 terminals
- Low VA Burden Wide operating band coils with Class H Insulation



HSN Code: 85369090

Frame size	$I_{th}$	Contact arrangement		Type	Item Code	Per Unit LP (₹) with AC Coil
		NO	NC			
1	16 A	2	2	HGR 22	IHHAC22*	1631.00
		3	1	HGR 31	IHHAC31*	
		4	0	HGR 40	IHHAC40*	
		0	4	HGR 04	IHHAC04*	
		1	3	HGR 13	IHHAC13*	

\*To complete the Item Code suffix the coil voltage from the coil voltage table  
Note: Control relay is not available in wide band

# Magnetic Contactor

## HGS 2 Pole Contactor with AC Coil

### Features:

- Common Accessories with HGS Range
- Compliance to IEC 60947-4-1



HSN Code: 85369090

Frame Size	AC-3 Duty Rating at 415 V, 50 Hz	AC-1 Duty Rating at 415 V, 50 Hz	Power Poles	In-built Auxiliary Contacts		Item Code	Per Unit LP (₹)
	$I_e$ A	$I_{th}$ A		NO	NC		
1	9 A	25 A	2	0	0	IHPHF009100*	1286.00
	12 A	25 A	2	0	0	IHPHF012100*	1491.00
	18 A ▲	40 A	2	0	0	IHPHF018100*	1728.00
	22 A	40 A	2	0	0	IHPHF022100*	1863.00
2	25 A	45 A	2	0	0	IHPHF025200*	2020.00
	32 A	55 A	2	0	0	IHPHF032200*	4256.00
	40 A	60 A	2	0	0	IHPHF040200*	6340.00
3	50 A	70 A	2	0	0	IHPHF050300*	7955.00
	65 A ▲	85 A	2	0	0	IHPHF065300*	11524.00
4	75 A	110 A	2	0	0	IHPHF075400*	13203.00
	85 A	125 A	2	0	0	IHPHF085400*	16022.00
	100 A	135 A	2	0	0	IHPHF100400*	20596.00

▲ Stockable Item

For details on technical parameters & non stockable items contact nearest sales office.

# Magnetic Contactor

## 3 Pole HGS - R Contactor



### Features:

- 3Pole AC3 duty contactor 9 A - 100 A
- Specially Designed for AC1/AC3 Duty contactor.
- Extra Wide Band Coil with Class H insulation.
- Common accessories for both HGS contactor & HGS R contactor.
- In built Auxiliary 2NO+2NC contact in Frame 3 & 4.
- Suitable for ring terminal in all ratings.
- Finger proof IP 20 terminals.

HSN Code: 85369090

Frame Size	AC-3 Duty Rating at 415 V, 50 Hz	AC-1 Duty Rating at 415 V, 50 Hz	Power Poles	In-built Auxilliary Contacts		Type	Item Code	Per Unit LP (₹)
	I <sub>e</sub> A	I <sub>th</sub> A		NO	NC			
1	9 A ▲	25 A	3	1	0	HGSR 9	IHPRA009110*	1539.00
	9 A	25 A	3	0	1	HGSR 9	IHPRA009101*	1539.00
	12 A ▲	25 A	3	1	0	HGSR 12	IHPRA012110*	1793.00
	12 A	25 A	3	0	1	HGSR 12	IHPRA012101*	1793.00
	18 A ▲	40 A	3	1	0	HGSR 18	IHPRA018110*	2085.00
	18 A	40 A	3	0	1	HGSR 18	IHPRA018101*	2085.00
	22 A ▲	40 A	3	1	0	HGSR 22	IHPRA022110*	2231.00
	22 A	40 A	3	0	1	HGSR 22	IHPRA022101*	2231.00
2	25 A ▲	45 A	3	1	0	HGSR 25	IHPRA025210*	2949.00
	25 A	45 A	3	0	1	HGSR 25	IHPRA025201*	2949.00
	32 A ▲	55 A	3	1	0	HGSR 32	IHPRA032210*	5471.00
	32 A	55 A	3	0	1	HGSR 32	IHPRA032201*	5471.00
	40 A ▲	60 A	3	1	0	HGSR 40	IHPRA040210*	8154.00
	40 A	60 A	3	0	1	HGSR 40	IHPRA040201*	8154.00
3	50 A ▲	70 A	3	2	2	HGSR 50	IHPRA050322*	11011.00
	65 A ▲	85 A	3	2	2	HGSR 65	IHPRA065322*	13792.00
4	75 A ▲	110 A	3	2	2	HGSR 75	IHPRA075422*	16503.00
	85 A ▲	125 A	3	2	2	HGSR 85	IHPRA085422*	19451.00
	100 A ▲	125 A	3	2	2	HGSR 100	IHPRA100422*	28026.00

### Coil Voltage Selection Table

\*To complete the Item Code suffix the coil voltage from the coil voltage table  
 Note: 1. For additional aux. contacts front/side mounted and mechanical interlock - refer accessories table on page no. 54  
 2. Standard Spare coil are available on request on page no 54

Note : For other coil voltages, Contact to nearest branch  
 To avoid Coil burning due to Neutral Floaring conditions, use Wide band Coils

Frame Size	AC Coil Codes for Nominal Voltage at 50/60 Hz			
	H	N	Wide Band Coils	
			S	W
1	110 V		150 V - 300 V ▲	260 V - 440 V ▲
2	110 V		150 V - 300 V ▲	260 V - 440 V ▲
3	110 V	180 V - 280 V	-	260 V - 440 V ▲
4	110 V	180 V - 280 V	-	260 V - 440 V ▲

▲ Stockable Item

For details on technical parameters & non stockable items contact nearest sales office.

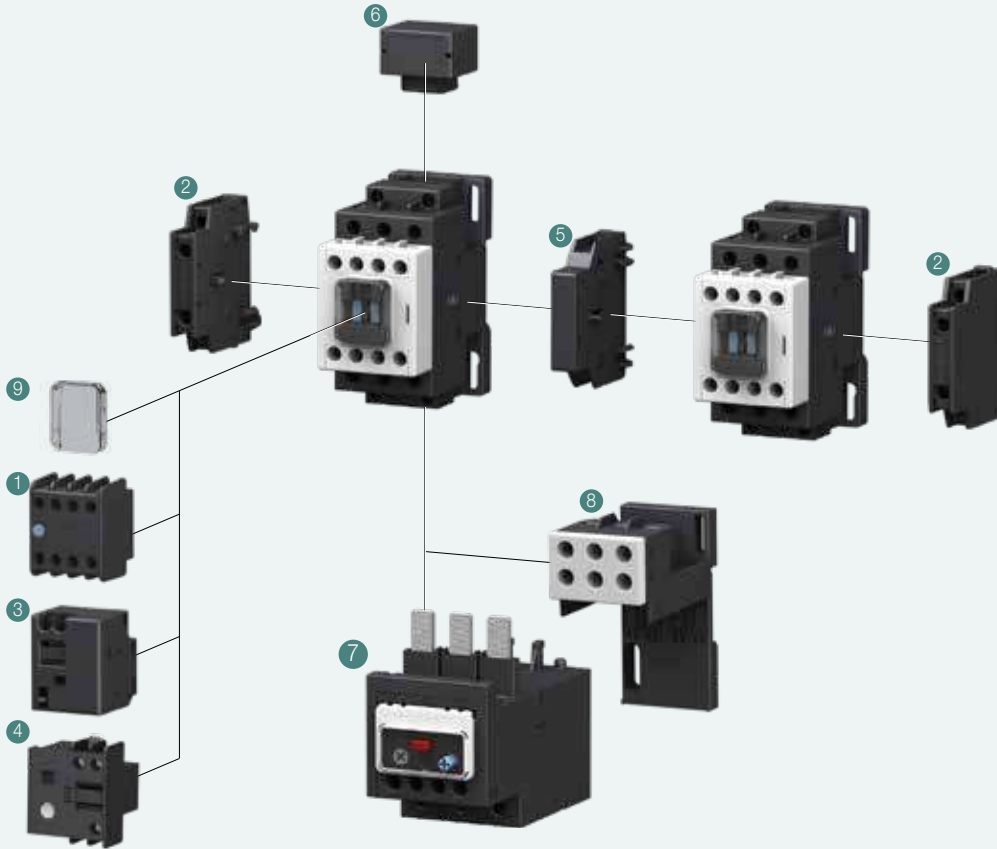

## 9 - 100 AF

- Auxiliary Contact Block (Front Side) HGS TB
- Auxiliary Contact Block (Left/Right Side) HGS SB
- Mechanical Latching Block HGS LB 100
- Timer HGS ET
- Interlock Unit HGS IU
- Surge Absorber HGS RC/CD
- Thermal Overload Relay HGST
- Separate Mounting Base HGSTMB
- Front Safety Cover

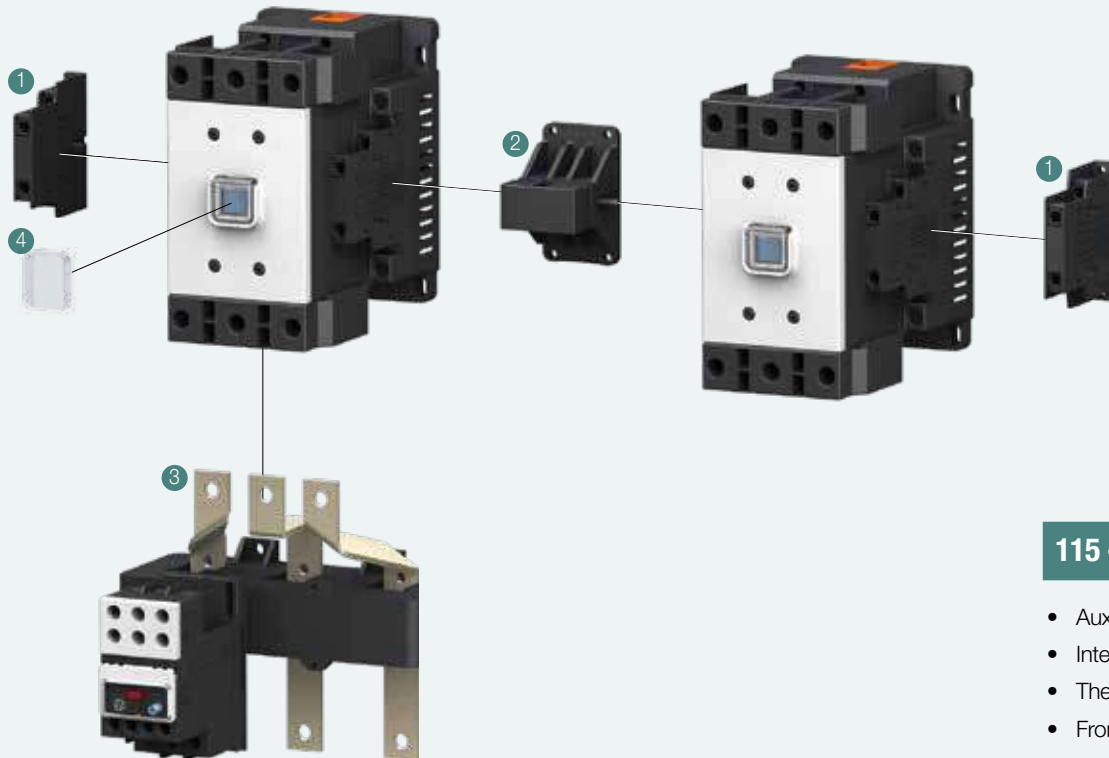

## 115 - 800 AF

- Auxiliary Contact Block HGS SB
- Interlock Unit HGS IU
- Thermal Overload Relay HGST
- Front Safety Cover

## Accessories - HGS Series Contactors



HSN Code: 85389000

Description	Configuraton	Suitable for	Item Code	Per Unit LP (₹)
Aux Contact Block (Side Mounting)	1NO + 1NC ▲	HGS 9-HGS 40 (For all contactors in Frame-1 and Frame-2)	ISSPCU1969	1048.00
		HGS50-HGS 100 (For all contactors in Frame-3 and Frame-4)	ISSPCU1970	
		HGS115- HGS 800	ISSPCU1971	1242.00
Aux Contact Block (Top Mounting)	2NC	HGS9-HGS100 (For all contactors in Frame-1 to Frame-4)	ISSPCU1961	648.00
	1NO + 1NC ▲		ISSPCU1962	
	2NO		ISSPCU1963	
	4NC		ISSPCU1964	1086.00
	1NO + 3NC		ISSPCU1965	
	2NO + 2NC ▲		ISSPCU1966	
	3NO + 1NC		ISSPCU1967	
4NO	ISSPCU1968			
Mechanical Interlock Unit		HGS 9-HGS 40 ▲ (For all contactors in Frame-1 and Frame-2)	ISSPCU1972	1415.00
		HGS50-HGS 100 (For all contactors in Frame-3 and Frame-4)	ISSPCU1973	3321.00
		HGS115- HGS 265	ISSPCU1974	5886.00
		HGS 300- HGS 800	ISSPCU1975	6664.00
Mechanical Latching Block (Top Mounting)	220 V AC	HGS 9-HGS 100 (For all contactors in Frame-1 to Frame-4)	ISSPCU1976	3332.00
Electronic Timer (Top Mounting)		HGS 9-HGS 100 (For all contactors in Frame-1 to Frame-4)	ISSPCU1977	4504.00
Surge Absorber* (Surge Suppressor Type RC)	220 V - 240 V AC	HGS 9-HGS 100 (For all contactors in Frame-1 to Frame-4)	ISSPCU1984	2846.00

# - One contactor of Frame-1 and another contactor of Frame-2 can also be interlocked using this Mechanical Interlock Unit.

\*Contact to nearest branch - ● For other voltages in RC type surge suppressors ● For other type of surge suppressors

## Spare Coils - HGS Contactors (Refer Frame Sizes in Respective Contactor Table)

HSN Code: 85389000

Suitable for	Coil Type	Voltage	Item Code	Per Unit LP (₹)
"For all Frame-1 Contactors (HGS 9 to HGS 22)"	AC	110 V	ISSPCU1987	940.00
		240 V	ISSPCU1989	
		415 V	ISSPCU2050	
		150 V-300 V	ISSPCU2215	
		260 V-440 V	ISSPCU2134	
"For all Frame-2 Contactors (HGS 25-HGS 40)"	AC	110 V	ISSPCU1995	3041.00
		240 V	ISSPCU1997	
		415 V	ISSPCU2053	
		150 V-300 V	ISSPCU2216	
		260 V-440 V	ISSPCU2135	
"For all Frame-3 Contactors (HGS 50-HGS 65)"	AC	110 V	ISSPCU2003	3041.00
		240 V	ISSPCU2005	
		415 V	ISSPCU2007	
		260 V-440 V	ISSPCU2136	
"For all Frame-4 Contactors (HGS 75-HGS 100)"	AC	110 V	ISSPCU2011	3510.00
		240 V	ISSPCU2013	
		415 V	ISSPCU2015	
		260 V-440 V	ISSPCU2137	
"For Frame-5 Contactors (HGS 115-HGS 150)"		100 Vac-240 Vac	ISSPCU1979	9477.00
		110 Vdc -220 Vdc		
		380 Vac-450 Vac		
"For Frame-6 Contactors (HGS 185-HGS 265)"		100 Vac-240 Vac	ISSPCU1980	3414.00
		110 Vdc -220 Vdc		
		380 Vac-450 Vac		
"For Frame-7 Contactors (HGS 300-HGS 500)"		100 Vac-240 Vac	ISSPCU1981	17448.00
		110 Vdc -220 Vdc		
		380 Vac-450 Vac		
"For Frame-8 Contactors (HGS 630-HGS 800)"		110 Vac-127 Vac	ISSPCU2480	35754.00
		100 Vdc -110 Vdc		
		200 Vac-240 Vac		
		200 Vdc -220 Vdc		
		380 Vac-450 Vac	ISSPCU2104	

▲ Stockable Item

For details on technical parameters & non stockable items contact nearest sales office.

# Thermal Over Load Relay (Auto/ Manual Reset) - HGST Series



## Features:

- Range : 0.12 A – 800 A available in 8 Frames, Trip class - 10 A
- Conforms to IS/IEC 60947-4-1
- Protection against overload & phase loss protection
- Auto / manual reset facility
- Contactor mounting / Individual mounting with adaptor
- Transparent protection cover for dust application

HSN Code: 85364900

Relay Fr. size	Relay Range (A)	Suitable for Contactor Frame size	Type	Item Code	Per Unit LP (₹)	
1	0.12 A - 0.18 A	HGS 9 HGS 12 HGS 18 HGS 22	HGST 18	IHHR13CA	2897.00	
	0.18 A - 0.26 A			IHHR13CB		
	0.25 A - 0.35 A			IHHR13CC		
	0.34 A - 0.5 A			IHHR13CD		
	0.5 A - 0.7 A			IHHR13CE		
	0.6 A - 0.9 A			IHHR13CF		
	0.8 A - 1.2 A			IHHR13CG		
	1.1 A - 1.6 A ▲			IHHR13CH		
	1.5 A - 2.1 A ▲			IHHR13CJ		
	2 A - 3 A ▲			IHHR13CZ		
	2.8 A - 4.2 A ▲			IHHR13CK		
	3 A - 5 A ▲			IHHR13CL		
	4 A - 6 A ▲			IHHR13CM		
	5.6 A - 8 A ▲			IHHR13CN		
6 A - 9 A ▲	IHHR13CP	2927.00				
8 A - 12 A ▲	IHHR13CR	3219.00				
12 A - 18 A ▲	IHHR13CT	3219.00				
2	7 A - 10.0 A	HGS 25 HGS 32 HGS 40	HGST 40	IHHR23CQ	3219.00	
	8 A - 12.0 A			IHHR23CR		
	12 A - 18 A ▲			IHHR23CT		
	15 A - 22 A ▲			IHHR23CU		
	17 A - 25 A ▲			IHHR23CV		3591.00
	22 A - 32 A ▲			IHHR23CW		4547.00
28 A - 40 A	IHHR23CX	4715.00				
3	7 A - 10.0 A	HGS 50 HGS 65	HGST 65	IHHR33CQ	5627.00	
	8 A - 12.0 A			IHHR33CR		
	12 A - 18 A			IHHR33CT		
	15 A - 22 A			IHHR33CU		
	17 A - 25 A			IHHR33CV		
	22 A - 32 A			IHHR33CW		
	28 A - 40 A			IHHR33CX		6669.00
	34 A - 50 A ▲			IHHR33CY		
	45 A - 65 A			IHHR33C1		7350.00

Relay Fr. size	Relay Range (A)	Suitable for Contactor Frame size	Type	Item Code	Per Unit LP (₹)	
4	17 A - 25 A	HGS 75 HGS 85 HGS 100	HGST 100	IHHR43CV	6534.00	
	22 A - 32 A			IHHR43CW		
	28 A - 40 A			IHHR43CX		
	34 A - 50 A			IHHR43CY		
	45 A - 65 A			IHHR43C1		
	52 A - 75 A			IHHR43C2		8273.00
	59 A - 85 A			IHHR43C3		
	70 A - 100 A			IHHR43C4		9218.00
5	48 A - 80 A	HGS 115 HGS 130 HGS 150	HGST 150	IHHR53C5	13792.00	
	69 A - 115 A			IHHR53C6		
	78 A - 130 A			IHHR53C7		
	90 A - 150 A			IHHR53C8		
6	48 A - 80 A	HGS 185 HGS 225 HGS 265	HGST 265	IHHR63C5	14818.00	
	69 A - 115 A			IHHR63C6		
	78 A - 130 A			IHHR63C7		
	90 A - 150 A			IHHR63C8		
	111 A - 185 A			IHHR63C9		
	135 A - 225 A			IHHR63C11		16346.00
159 A - 265 A	IHHR63C12	17993.00				
7	90 A - 150 A	HGS 300 HGS 400 HGS 500	HGST 500	IHHR73C8	18004.00	
	111 A - 185 A			IHHR73C9		
	135 A - 225 A			IHHR73C11		
	159 A - 265 A			IHHR73C12		
	180 A - 300 A			IHHR73C13		
	240 A - 400 A			IHHR73C14		19721.00
	300 A - 500 A			IHHR73C15		22983.00
8	378 A - 630 A	HGS 630 HGS 800	HGST 800	IHHR83C16	49281.00	
	480 A - 800 A			IHHR83C17		

## Relay Adapter

HSN Code: 85389000

Suitable for	Item code	Per Unit LP (₹)
For all Frame-1 Contactors (HGS 9 to HGS 22)	ISSPCU2681	530.00
For all Frame-2 Contactors (HGS 25 to HGS 40)	ISSPCU2682	708.00

▲ Stockable Item

For details on technical parameters & non stockable items contact nearest sales office.

# Magnetic Contactor Capacitor Duty Contactor

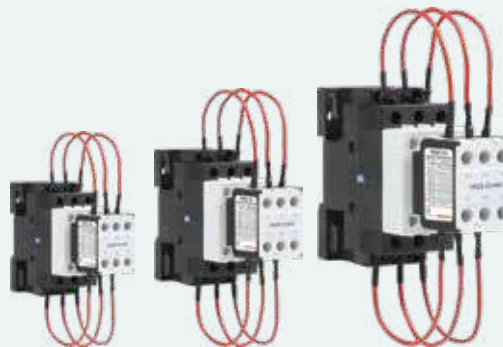

## Features:

- Range : 3 kVAr to 66 kVAr
- De-latching Type design of Resistor Switching Block
- Low VA Burden Wide operating band coils with Class H Insulation
- Common accessories with HGS Range
- High Operating Frequency - 240 Operations per hour
- Handle high inrush current capability
- Utilization category AC-6b
- Finger proof IP20 terminals

HSN Code: 85369090

Frame Size	kVAr Rating AC-6b		Inst. Aux. Contact		Item Code	Per Unit LP (₹)
	415 V / 440 V		NO	NC		
1	3 kVAr ▲		1	0	IHPHE003110*	3678.00
	3 kVAr		0	1	IHPHE003101*	3678.00
	5 kVAr ▲		1	0	IHPHE005110*	3856.00
	5 kVAr		0	1	IHPHE005101*	3856.00
	10 kVAr ▲		1	0	IHPHE010110*	4666.00
	10 kVAr		0	1	IHPHE010101*	4666.00
	12.5 kVAr		1	0	IHPHE12X110*	5276.00
	12.5 kVAr		0	1	IHPHE12X101*	5168.00
	15 kVAr ▲		1	0	IHPHE015110*	6464.00
	15 kVAr		0	1	IHPHE015101*	6464.00
2	20 kVAr ▲		1	0	IHPHE020210*	7107.00
	20 kVAr		0	1	IHPHE020201*	7107.00
	25 kVAr ▲		1	0	IHPHE025210*	8095.00
	25 kVAr		0	1	IHPHE025201*	8095.00
	33.3 kVAr ▲		1	0	IHPHE33X210*	11740.00
	33.3 kVAr		0	1	IHPHE33X201*	11740.00
3	33.3 kVAr		1	1	IHPHE33X311*	14148.00
	40 kVAr		2	2	IHPHE040322*	21741.00
4	50 kVAr ▲		2	2	IHPHE050422*	22626.00
	66 kVAr ▲		2	2	IHPHE066422*	26536.00

\*To complete the Item Code suffix the coil voltage from the coil voltage table  
33.3 kVAr contactor in Frame-3 can be used where higher terminal capacity is required.

## Coil Voltage Selection Table

3 kVAr - 66 kVAr AC Coil

Product	110 V AC	240 V AC	415 V AC	150 V AC - 300 V AC	260 V AC - 440 V AC
HGS Capacitor Duty Contactor (3 kVAr - 66 kVAr)	H	N ▲	T	S ▲	W

▲ Stockable Item  
For details on technical parameters & non stockable items contact nearest sales office.

#For Power Quality Solution  
kindly refer to page 83 & above



Scan for HGS Catalogue



Scan for Type-2  
Co-ordination Charts



# Motor Protection Circuit Breakers

MPCB Push button version	Rotary MPCB Fr 1	Rotary MPCB Fr 2
HGSM : Thermal Magnetic, 0.1 A - 32 A ■ Short Circuit + Overload Protection ■ Icu= 100 kA upto 10 A, Icu=15 kA for 9 A - 25 A & Icu= 10 kA for 24 A - 32 A	■ HGSTM : Thermal Magnetic, 0.1 A - 63 A ■ Short Circuit Protection + Overload Protection ■ Fr 1 - Icu= 100 kA upto 6.3 A & Icu= 50 kA from 6.3 A - 32 A Fr 2 - Icu= 50 kA from 11 A - 63 A	■ HGSMR : Magnetic, 0.16 A - 63 A ■ Short Circuit Protection ■ Fr 1 - Icu= 100 kA from 0.16 A - 6.3 A & Icu= 50 kA from 10 A - 32 A Fr 2 - Icu= 50 kA from 16 A - 63 A

## Range & Switching Capabilities

Type	Operating Method	Version	Protections Offered	Frame & Size	Ratings and Breaking Capacity		
					→ 63 A → 32 A		
HGSM	Push-Button	Thermal Magnetic	OL, SC, Single Phasing	Fr-1 45 mm	0.1 A - 10 A 100 kA	9 A - 25 A 15 kA	24 A - 32 A 10 kA
HGSTM	Rotary	Thermal Magnetic	OL, SC, Single Phasing	Fr-1 45 mm	0.1 A - 6.3 A 100 kA	6.3 A - 32 A 50 kA	
				Fr-2 55 mm	11 A - 63 A 50 kA		
HGSMR	Rotary	Magnetic	SC	Fr-1 45 mm	0.16 A - 6.3 A 100 kA	10 A - 32 A 50 kA	
				Fr-2 55 mm	16 A - 63 A 50 kA		



- ◆ Short circuit protection
- ◆ Over current protection
- ◆ Overload protection
- ◆ Phase loss protection
- ◆ Wide range of current adjustment dial

- ◆ Compact
- ◆ High breaking capacity
- ◆ Short circuit protective coordination
- ◆ Reduction in wiring work
- ◆ High switching durability
- ◆ Padlocking feature available
- ◆ Stand alone motor protection
- ◆ Common accessories

Circuit Breaker

Circuit Breaker

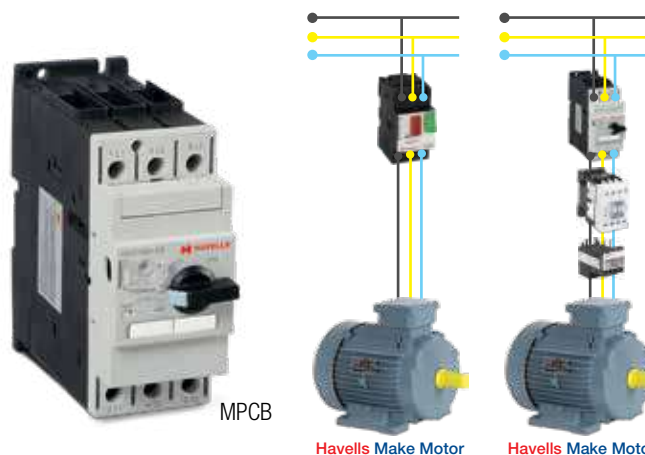

# Accessories Overview : Push Button MPCB

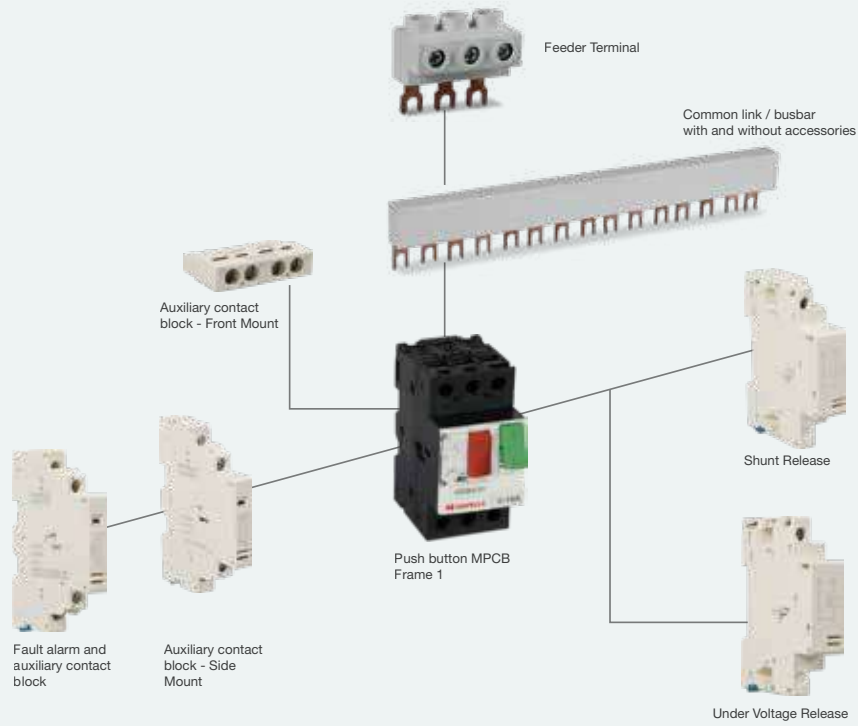

# Accessories Overview : Rotary MPCB

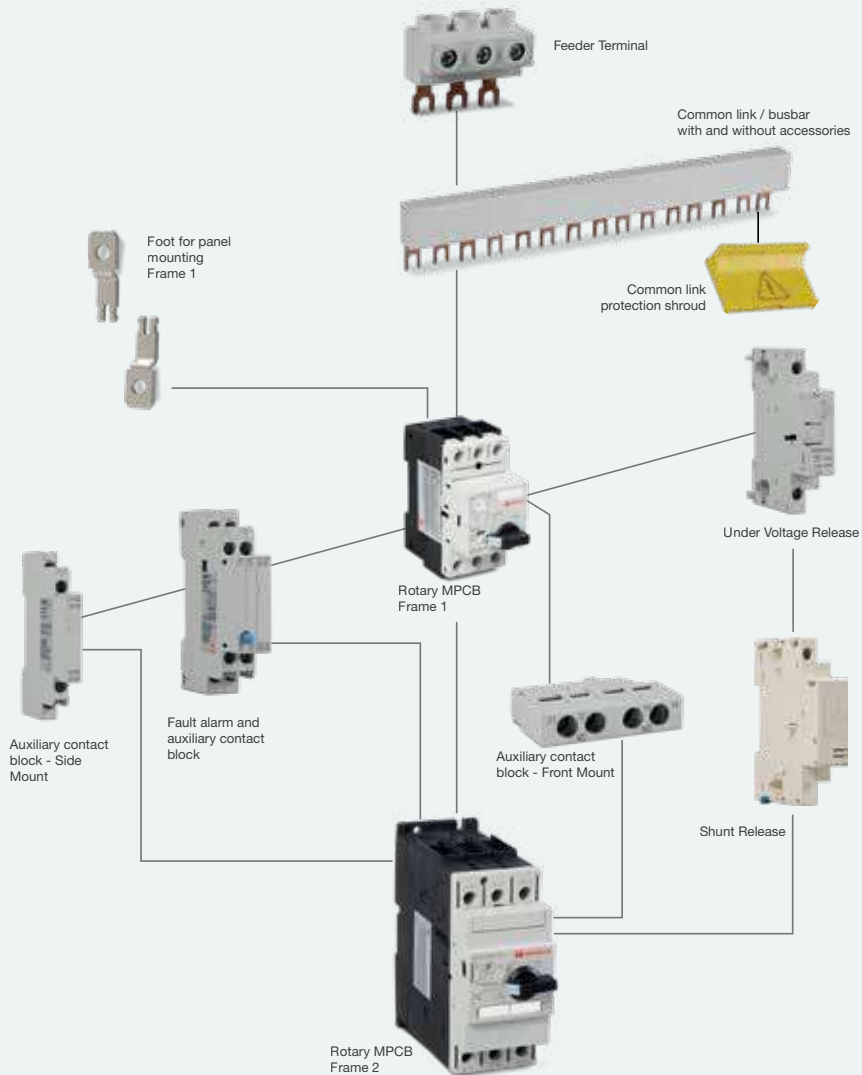

# MPCB - Motor Protection Circuit Breaker - HGSM Series



## MPCB specially coordinated for IE2, IE3 & IE4 Motors

### Push Button Version\*

#### Features:

- 1 Frame size - 45 mm width
- High Magnetic Setting - Makes it suitable for IE2, IE3 and IE4 Motors
- Tripping class: 10 A
- Mechanical Life: 100000 cycles
- Electrical Life: 100000 cycles
- Compliance to IEC 60947-2, IEC 60947-4-1
- Finger proof IP20 Terminals
- Lockable in OFF Position



## HGSM - Thermal Magnetic Series

HSN Code: 85362090

Frame	Model	Breaking Capacity kA 415 V, 50 Hz	Current Rating	Item Code	Per Unit LP (₹)
1	HGSM	100 kA	0.1 A - 0.16 A	IHHMPBA2A0	1491.00
			0.16 A - 0.25 A	IHHMPBB2B0	
			0.25 A - 0.4 A	IHHMPBC2D0	
			0.4 A - 0.63 A	IHHMPBD2E0	4752.00
			0.63 A - 1 A	IHHMPBE2F0	4785.00
			1 A - 1.6 A	IHHMPBF2G0	
			1.6 A - 2.5 A	IHHMPBG2R0	
			2.5 A - 4 A	IHHMPBH2I0	4958.00
		4 A - 6.3 A	IHHMPBJ2J0	5303.00	
		6.3 A - 10 A	IHHMPBK2K0		
		9 A - 14 A	IHHMPBL2L0		
		15 kA	13 A - 18 A	IHHMPBN2M0	6794.00
			17 A - 23 A	IHHMPBQ2T0	7150.00
			20 A - 25 A	IHHMPBS2N0	
			10 kA	24 A - 32 A	IHHMPBT2P0

## Motor Protection Circuit Breaker - HGSM Series Accessories

HSN Code: 85389000

Description	Configuraton	Suitable for	Item Code	Per Unit LP (₹)
Aux Contact Block (Side Mounting)	2NO	HGSM MPCB	ISSPCU2414	1124.00
	1NO + 1NC		ISSPCU2415	
Aux Contact Block (Top Mounting)	2NO		ISSPCU2412	
	1NO + 1NC		ISSPCU2413	
UV Release	110 V AC		ISSPCU2406	3122.00
	240 V AC		ISSPCU2407	
	415 V AC		ISSPCU2408	
Shunt Release	110 V AC		ISSPCU2409	
	240 V AC		ISSPCU2410	
	415 V AC		ISSPCU2411	
Fault Alarm	1NC + 1NO		ISSPCU2416	1550.00
	1NC + 1NC		ISSPCU2417	
	1NO + 1NO	ISSPCU2418		
Water proof Box IP55			ISSPCU2419	1850.00
Emergency Water proof Box IP55			ISSPCU2420	2000.00



▲ Stockable Item

For details on technical parameters & non stockable items contact nearest sales office.

Effective from 1st April, 2026

List Price (LP) are in Indian ₹ & as per Standard Terms & Conditions **HAVELLS 63**

# MPCB Motor Protection Circuit Breaker - HGSTMR / HGSMR Series



## MPCB specially coordinated for IE2, IE3 & IE4 Motors

### Features:

- Rotary Version - 2 Frame Sizes, 45 mm and 55 mm width
- Thermal magnetic version - Range from 0.1 A - 63 A, Trip class 10
- Magnetic Only version - Range from 0.16 A - 63 A
- Rated Operational Voltage  $U_i$  : 690 V
- High Magnetic Setting - Makes it suitable for IE2, IE3 and IE4 Motors
- Compliance to IEC 60947-2 and IEC 60947-4-1
- Finger proof IP20 Terminals
- Lockable in OFF Position
- Suitable for DIN channel and Base Mounting both
- CE Marking



### HGSTMR - Thermal Magnetic Series

### HGSMR - Only Magnetic Series

HSN Code: 85362090

HSN Code: 85362090

Fr.	Model	Breaking Capacity kA 415 V, 50 Hz	Current Rating	Item Code	Per Unit LP (₹)		
1	HGSTMR - A1	100 kA	0.1 A - 0.16 A	IHHMROA1AT	5363.00		
		100 kA	0.16 A - 0.25 A	IHHMROB1BT	5363.00		
		100 kA	0.25 A - 0.4 A	IHHMROC1DT	5363.00		
		100 kA	0.4 A - 0.63 A	IHHMROD1ET	5363.00		
		100 kA	0.63 A - 1 A	IHHMROE1FT	5363.00		
		100 kA	1 A - 1.6 A	IHHMROF1GT	6119.00		
		100 kA	1.6 A - 2.5 A	IHHMROG1RT	6119.00		
		100 kA	2.5 A - 4 A	IHHMROH1IT	6119.00		
		100 kA	4 A - 6.3 A	IHHMROJ1JT	6119.00		
		50 kA	6.3 A - 10 A	IHHMROK1KT	6891.00		
		50 kA	10 A - 16 A	IHHMROM1MT	6891.00		
		50 kA	16 A - 20 A	IHHMROP1TT	8414.00		
		50 kA	20 A - 25 A	IHHMROS1NT	8414.00		
		50 kA	25 A - 32 A	IHHMROT1PT	15293.00		
		2	HGSTMR - A2	50 kA	11 A - 16 A	IHHMROM3MT	18355.00
				50 kA	14 A - 20 A	IHHMROP3TT	18355.00
50 kA	18 A - 25 A			IHHMROS3NT	18355.00		
50 kA	22 A - 32 A			IHHMROT3PT	24473.00		
50 kA	28 A - 40 A			IHHMROU3QT	24473.00		
50 kA	36 A - 45 A			IHHMROV3ST	24473.00		
50 kA	40 A - 50 A			IHHMROW3ST	24473.00		
50 kA	52 A - 63 A			IHHMROX3XT	24473.00		

Fr.	Model	Breaking Capacity kA 415 V, 50 Hz	Current Rating	Item Code	Per Unit LP (₹)		
1	HGSMR - A1	100 kA	0.16 A	IHHMROA1AM	4823.000		
		100 kA	0.25 A	IHHMROB1BM	4823.000		
		100 kA	0.4 A	IHHMROC1DM	4823.000		
		100 kA	0.63 A	IHHMROD1EM	4823.000		
		100 kA	1.0 A	IHHMROE1FM	4823.000		
		100 kA	1.6 A	IHHMROF1GM	5508.000		
		100 kA	2.5 A	IHHMROG1RM	5508.000		
		100 kA	4.0 A	IHHMROH1IM	5508.000		
		100 kA	6.3 A	IHHMROJ1JM	5508.000		
		50 kA	10 A	IHHMROK1KM	6205.000		
		50 kA	16 A	IHHMROM1MM	6205.000		
		50 kA	20 A	IHHMROP1TM	7577.000		
		50 kA	25 A	IHHMROS1NM	7577.000		
		50 kA	32 A	IHHMROT1PM	13770.000		
		2	HGSMR - A2	50 kA	16 A	IHHMROM3MM	16519.000
				50 kA	20 A	IHHMROP3TM	16519.000
50 kA	25 A			IHHMROS3NM	16519.000		
50 kA	32 A			IHHMROT3PM	22022.000		
50 kA	40 A			IHHMROU3QM	22022.000		
50 kA	45 A			IHHMROV3SM	22022.000		
50 kA	50 A			IHHMROW3SM	22022.000		
50 kA	63 A			IHHMROX3XM	22022.000		

▲ Stockable Item

For details on technical parameters & non stockable items contact nearest sales office.

# MPCB specially coordinated for IE2, IE3 & IE4 Motors



## Motor Protection Circuit Breaker - HGSTMR / HGSMR Series Accessories

HSN Code: 85389000

Description	Configuraton	Suitable for	Item Code	Per Unit LP (₹)
Aux Contact Block (Side Mounting)	2NO	HGSTMR / HGSMR MPCB	ISSPDU0062	1836.00
	2NC		ISSPDU0061	1836.00
	1NO + 1NC		ISSPDU0063	1836.00
Fault Alarm + Aux Contact Block (Side Mounting)	2 NO + 2NC		ISSPDU0073	1836.00
Aux Contact Block (Top Mounting)	1NO + 1NC		ISSPDU0060	1534.00
UV Release	24 V AC / 28 V AC		ISSPDU0069	3678.00
	180 V AC		ISSPDU0066	3678.00
	208 V AC		ISSPDU0067	3678.00
	240 V AC		ISSPDU0064	3678.00
Shunt Release	100 V AC - 127 V AC		ISSPDU0071	3678.00
	20 V AC - 24 V AC	ISSPDU0070	3678.00	
	200 V AC - 240 V AC	ISSPDU0072	3678.00	
Operating Handle	HGSRHBG-A1 OPERATING HANDLE-ROT	ISSPDU0089	1993.00	
	HGSRHBG-A2 OPERATING HANDLE-ROT	ISSPDU0091	2452.00	
	HGSRHRY-A1 OPERATING HANDLE-ROT	ISSPDU0090	1993.00	
	HGSRHRY-A2 OPERATING HANDLE-ROT	ISSPDU0092	2452.00	
Enclosure	HGSREBG-A1 IP65/L ENCLOSURE-ROT	ISSPDU0076	5665.00	
	HGSREBG-A1 IP65/S ENCLOSURE-ROT	ISSPDU0074	4904.00	
	HGSRERY-A1 IP65/L ENCLOSURE-ROT	ISSPDU0077	5665.00	
	HGSRERY-A1 IP65/S ENCLOSURE-ROT	ISSPDU0075	4904.00	
Feeder Terminal	HGSRFT-A1 3P FEEDER TERMINALS	ISSPDU0079	1226.00	
Terminal Barrier	HGSRBT-A1 3P TERMINAL BARRIER	ISSPDU0080	157.00	
Common Link	HGSRCL-A1 452MM COMMON LINK	ISSPDU0081	1080.00	
	HGSRCL-A1 453MM COMMON LINK	ISSPDU0082	1226.00	
	HGSRCL-A1 454MM COMMON LINK	ISSPDU0083	1453.00	
	HGSRCL-A1 455MM COMMON LINK	ISSPDU0084	1685.00	
	HGSRCL-A1 542MM COMMON LINK	ISSPDU0085	1307.00	
	HGSRCL-A1 543MM COMMON LINK	ISSPDU0086	1453.00	
	HGSRCL-A1 544MM COMMON LINK	ISSPDU0087	1685.00	
	HGSRCL-A1 545MM COMMON LINK	ISSPDU0088	1912.00	



▲ Stockable Item

For details on technical parameters & non stockable items contact nearest sales office.

# Industrial Motor Starter - HGS



# HGS - Trusted Global Range

## Motor Starters

Motor Control Solutions for higher Safety, Reliability & Performance



DOL Starters  
Ratings - 0.55 kW to 37 kW  
(0.75 HP to 50 HP)



ASD Starters  
Ratings - 3.7 kW to 110 kW  
(5 HP to 150 HP)



ASD 3 $\phi$  Submersible Starters  
Ratings - 22 kW to 37 kW  
(30 HP to 50 HP)



ASD 3 $\phi$  Submersible Starters DLX  
(with Short-circuit Protection)  
Ratings - 22 kW to 37 kW  
(30 HP to 50 HP)

# Industrial Motor Starter - HGS

## Direct Online Starter - HGS Series



### Features:

- Range : 0.55 kW to 37 kW (0.75 HP to 50 HP)
- Conforms to IS/IEC 60947-4-1
- Provided with Protection Degree IP 54
- Extended wide band coil
- FRLS (Fire retardant low smoke) Internal wiring
- Starter Type - Air Break
- Class H Insulation

HSN Code: 85369010

HP	kW	Contactor Rating	Overload Relay Range (A)	Item Code	Per Unit LP (₹)
0.75 HP ▲	0.55 kW	12 A	1.5 A - 2.1 A	IHHDOLFATE	4265.00
1 HP	0.75 kW	12 A	2 A - 3 A	IHHDOLGAWE	
2 HP ▲	1.5 kW	12 A	2.8 A - 4.2 A	IHHDOLHAWE	
3 HP ▲	2.2 kW	12 A	4.0 A - 6.0 A	IHHDOLJAWE	
5 HP ▲	3.7 kW	12 A	6 A - 9 A	IHHDOLLAWE	
7.5 HP ▲	5.5 kW	18 A	12 A - 18 A	IHHDOLMAWE	5120.00
10 HP ▲	7.5 kW	22 A	12 A - 18 A	IHHDOLNAWE	
15 HP ▲	11 kW	32 A	17 A - 25 A	IHHDOLPBWE	8255.00
20 HP	15 kW	32 A	22 A - 32 A	IHHDOLWBW	13290.00
25 HP	18.5 kW	40 A	28 A - 40 A	IHHDOLXBW	16110.00
30 HP	22 kW	50 A	34 A - 50 A	IHHDOLYCW	20860.00
40 HP	30 kW	65 A	45 A - 65 A	IHHDOL1CT	25760.00
50 HP	37 kW	85 A	59 A - 85 A	IHHDOL3DT	29875.00

## Fully Automatic Star-Delta Starter (ASD) - HGS Series



### Features:

- Range : 3.7 kW to 110 kW (5 HP to 150 HP)
- Conforms to IS/IEC 60947-4-1
- Provided with Protection Degree IP 54
- Extended wide band coil
- FRLS (Fire retardant low smoke) Internal wiring
- Starter Type - Air Break
- Class H Insulation

HSN Code: 85369010

HP	kW	Contactor Size	Overload Relay Range (A)	Item Code	Per Unit LP (₹)
5 HP	3.7 kW	12 A	4.0 A - 6 A	IHHASDMAW	17680.00
7.5 HP	5.5 kW	18 A	6.0 A - 9 A	IHHASDNAW	17680.00
10 HP ▲	7.5 kW	18 A	8.0 A - 12 A	IHHASDRAW	17680.00
12.5 HP	9.3 kW	18 A	8.0 A - 12 A	IHHASDTAW	17925.00
15 HP ▲	11 kW	22 A	12 A - 18.0 A	IHHASDTBW	17995.00
20 HP ▲	15 kW	25 A	15 A - 22 A	IHHASDUBW	20250.00
25 HP ▲	18.5 kW	32 A	17 A - 25 A	IHHASDVWBW	22795.00
30 HP ▲	22 kW	32 A	22 A - 32 A	IHHASDWBW	24870.00
35 HP	26 kW	32 A	28 A - 40 A	IHHASDXBW	36915.00
40 HP	30 kW	50 A	28 A - 40 A	IHHASDXCW	51030.00
50 HP	37 kW	50 A	34 A - 50 A	IHHASDYCW	63025.00
60 HP	45 kW	50 A	45 A - 65 A	IHHASD1CWA	92480.00
75 HP	55 kW	65 A	45 A - 65 A	IHHASD1CWB	101730.00
90 HP	67.5 kW	85 A	59 A - 85 A	IHHASD3DW	119065.00
100 HP	75 kW	100 A	70 A - 100 A	IHHASD4DW	124930.00
125 HP	90 kW	115 A	78 A - 130 A	IHHASD7ET	172095.00
150 HP	110 kW	150 A	90 A - 150 A	IHHASD8ET	174570.00

▲ Stockable Item

For details on technical parameters & non stockable items contact nearest sales office.

## Automatic Star Delta Submersible Starter (STD) - HGS Series



### Features:

- Range : 22 kW to 37 kW (30 HP to 50 HP)
- Conforms to IS/IEC 60947-4-1
- Provided with Protection Degree IP 54
- Extended wide band coil
- FRLS (Fire retardant low smoke) Internal wiring
- In-built metering
- Class H Insulation

HSN Code: 85369010

HP	kW	Full load Line Current	Full Load phase current	Contactor Size	Overload Relay Range (A)	Item Code	Per Unit LP (₹)
30 HP	22 kW	43.5 A	25.12 A	50 A	28 A - 40 A	IHHSSDXCW	51500.00
35 HP	26 kW	50.75 A	29.30 A	50 A	34 A - 50 A	IHHSSDYCWA	54580.00
40 HP	30 kW	58 A	33.49 A	65 A	34 A - 50 A	IHHSSDYCWB	60025.00
45 HP	33.6 kW	65.25 A	37.67 A	75 A	45 A - 65 A	IHHSSD1DW	75030.00
50 HP	37 kW	72.5 A	41.86 A	85 A	52 A - 75 A	IHHSSD2DW	81840.00

## Automatic Star Delta Submersible Starter DLX (with short-circuit Protection) - HGS Series



### Features:

- Range : 22 kW to 37 kW (30 HP to 50 HP)
- Conforms to IS/IEC 60947-4-1
- Provided with Protection Degree IP 54
- Extended wide band coil
- FRLS (Fire retardant low smoke) Internal wiring
- In-built metering & MCB
- Class H Insulation

HSN Code: 85369010









HP	kW	Full load Line Current	Full Load phase current	Contactor Size	Overload Relay Range (A)	TP MCB Rating (A)	Item Code	Per Unit LP (₹)
30 HP	22 kW	43.5 A	25.12 A	50 A	28 A - 40 A	100 A	IHHSDXCW	52980.00
35 HP	26 kW	50.75 A	29.30 A	50 A	34 A - 50 A	100 A	IHHSDYCWA	56115.00
40 HP	30 kW	58 A	33.49 A	65 A	34 A - 50 A	100 A	IHHSDYCWB	61665.00
45 HP	33.6 kW	65.25 A	37.67 A	75 A	45 A - 65 A	125 A	IHHSD1DW	76960.00
50 HP	37 kW	72.5 A	41.86 A	85 A	52 A - 75 A	125 A	IHHSD2DW	83900.00

▲ Stockable Item

For details on technical parameters & non stockable items contact nearest sales office.

# Spares for Industrial Motor Starter - HGS Series

HSN Code: 85389000

Type	Item Code	Per Unit LP (₹)	
Start Push Button - Green	ICELL00002	280.00	
Stop Push Button - Red	ICELL00003		
Motor ON Indicating Light-Green	ICELKL00015	440.00	
Motor Trip Indicating Light-Yellow	ICELKL00013		
SPP	ISCELXL00063	4675.00	
Combined Voltmeter & Ammeter	ISCEMLX0007	1785.00	
Terminal Block 6 way	ICELPSMX001	675.00	
Terminal Block 3 way	ICELPSMX002	410.00	
VOLT.SEL SW. C/G	ICELQL00021	625.00	
Electronic Timer	ICELRPSL005	4030.00	
Mini Rocker Switch - SPP By Pass	ISCELEL00218	72.00	

▲ Stockable Item

For details on technical parameters & non stockable items contact nearest sales office.

# Agricultural Motor Starter



# Agricultural Motor Starter



3  $\phi$  Urja Lite DOL Starters  
Ratings - 0.19 kW to 7.5 kW  
(0.25 HP to 10 HP)



1  $\phi$  & 3  $\phi$  Urja DOL Starters  
Ratings - 0.55 kW to 11 kW  
(0.75 HP to 15 HP) - 3  $\phi$   
Ratings - 0.37 kW to 2.2 kW  
(0.5 HP to 3 HP) - 1  $\phi$



3 $\phi$  DOL Starter Submersible  
Pump Controller  
Ratings - 0.75 kW to 11 kW  
(1 HP to 15 HP)



3 $\phi$  ASD Submersible  
Pump Controller  
Ratings - 3.7 kW to 15 kW  
(5 HP to 20 HP)



1 $\phi$  Submersible Starters with Start  
& Run Capacitor (Urja Kavach)  
Ratings - 0.37 kW to 2.2 kW  
(0.5 HP to 3 HP)



1 $\phi$  Submersible Pump Controller  
(Urja Kavach)  
Ratings - 0.37 kW to 2.2 kW  
(0.5 HP to 3 HP)

# Motor Starter

## urja Urja Lite DOL Starters



### Features:

- Range: upto 10 HP DOL
- Wide Band Coil 380 V (250 V - 440 V)
- Enclosure Dust, Vermin & Moisture Proof
- Quick Fit Technology
- Hight Electrical & Mechanical Life

HSN Code: 85369010

HP	kW	Contactor	O/L Relay	Motor Starter	
		(A)	(A)	Item Code	Per Unit LP (₹)
0.5 HP	0.37 kW	12 A	1 A - 1.6 A	IHADOB1LH	3805.00
1 HP	0.75 kW	12 A	1.5 A - 2.5 A	IHADOB1LH	3805.00
2 HP ▲	1.5 kW	12 A	2.5 A - 4 A	IHADOB1LH	3805.00
3 HP ▲	2.2 kW	12 A	4 A - 6.5 A	IHADOB1LH	3805.00
5 HP ▲	3.7 kW	12 A	6 A - 10 A	IHADOB1LH	3805.00
7.5 HP ▲	5.6 kW	16 A	9 A - 14 A	IHADOB1LH	3805.00
10 HP ▲	7.5 kW	25 A	13 A - 21 A	IHADOB1LH	3805.00

## urja DOL Starters 3 Phase - Agri Series

### Features:

- Range : 0.55 kW to 11 kW (0.75 HP to 15 HP)
- Conforms to IS/IEC 60947-4-1
- Provided with Protection Degree IP 54
- Extended wide band coil
- FRLS (Fire retardant low smoke) Internal wiring
- Starter Type - Air Break
- Class H Insulation



### Direct Online Starter - (Ideal for Agri Pump Application)

HSN Code: 85369010

HP	kW	Contactor	O/L Relay	Motor Starter	
		(A)	(A)	Item Code	Per Unit LP (₹)
1 HP ▲	0.75 kW	16 A	1.58 A - 2.5 A	IHADOAF1K	4410.00
2 HP ▲	1.5 kW	16 A	2.4 A - 3.8 A	IHADOAG1K	
3 HP ▲	2.2 kW	16 A	3.8 A - 6.0 A	IHADOAH1K	
5 HP ▲	3.7 kW	16 A	6.0 A - 9.3 A	IHADOAJ1K	
7.5 HP ▲	5.5 kW	20 A ▲	8.9 A - 13.5 A	IHADOAK1K	4855.00
		20 A	13.2 A - 20 A	IHADOAK1KA	
		20 A	17.4 A - 24 A	IHADOAK1KB	
10 HP ▲	7.5 kW	20 A	13.2 A - 20 A	IHADOAL1K	
15 HP ▲	11 kW	25 A	17.4 A - 24 A	IHADOAM1K	6235.00

## urja DOL Starters Single Phase - Agri Series

### Features:

- Range : 0.37 kW to 2.2 kW (0.5 HP to 3 HP)
- Conforms to IS/IEC 60947-4-1
- Provided with Protection Degree IP 54
- Extended wide band coil
- FRLS (Fire retardant low smoke) Internal wiring
- Starter type Air break
- Class H Insulation



### Direct Online Starter Single Phase

HSN Code: 85369010

HP	kW	FLC (A)	Contactor (A)	O/L Relay (A)	Item Code	Per Unit LP (₹)
1 HP ▲	0.75 kW	6.24 A	20 A	6 A - 9.3 A	IHUDOLH1F1	2925.00
1.5 HP ▲	1.1 kW	9.15 A	20 A	8.9 A - 13.5 A	IHUDOLK1F1	
2 HP ▲	1.5 kW	12.47 A	20 A	13.2 A - 20 A	IHUDOLK1FA	3000.00
3 HP ▲	2.2 kW	18.71 A	25 A	17.4 A - 24 A	IHUDOLL1F1	

▲ Stockable Item

For details on technical parameters & non stockable items contact nearest sales office.

## urja Direct Online Starter Submersible Pump Controller (Standard)

3 Phase - Agri Series



### Features:

- Range : 0.75 kW to 11 kW (1 HP to 15 HP)
- Conforms to IS/IEC 60947-4-1
- Provided with Protection Degree IP 54
- SPP with auto manual switch
- FRLS (Fire retardant low smoke) Internal wiring
- Combined V / A meter, Voltmeter selector switch
- ON OFF indication

HSN Code: 85369010

HP	kW	Max. Operational Current (A)	Contactor AC3 (A)	OLR (A)	Item Code	Per Unit LP (₹)
1 HP	0.75 kW	1.90 A	20 A	1.58 A - 2.5 A	IHSDOAF1KA	13075.00
2 HP	1.5 kW	3.81 A	20 A	3.8 A - 6.0 A	IHSDOAH1KA	
3 HP ▲	2.2 kW	5.71 A	20 A	3.8 A - 6.0 A	IHSDOAH1KB	
5 HP ▲	3.7 kW	9.52 A	20 A	8.9 A - 13.5 A	IHSDOAK1KA	
7.5 HP ▲	5.5 kW	14.27 A	20 A	13.2 A - 20 A	IHSDOAL1KA	
10 HP ▲	7.5 kW	19.03 A	25 A	13.2 A - 20 A	IHSDOAL1KB	13760.00
12.5 HP	9.3 kW	23.79 A	32 A	17.4 A - 24 A	IHSDOAM1KA	14445.00
15 HP	11 kW	28.55 A	32 A	22 A - 30 A	IHSDOAN1KA	16040.00

## urja Automatic Star Delta Submersible Pump Controller (Standard)

3 Phase - Agri Series



### Features:

- Range : 3.75 kW to 15 kW (5 HP to 20 HP)
- Conforms to IS/IEC 60947-4-1
- Provided with Protection Degree IP 54
- SPP with auto manual switch
- FRLS (Fire retardant low smoke) Internal wiring
- Combined V / A meter, Voltmeter selector switch
- ON OFF indication
- Star Delta Timer

HSN Code: 85369010

HP	Max Operating Current 135% (A)	Phase Current (A)	OLR (A)	Contactor AC3 (A)	Item Code	Per Unit LP (₹)
5 HP	10.13 A	5.85 A	3.8 A - 6.0 A	20 A	IHSASAH1KA	22970.00
7.5 HP	15.19 A	8.77 A	6 A - 9.3 A	20 A	IHSASAJ1KA	
10 HP ▲	20.25 A	11.69 A	8.9 A - 13.5 A	20 A	IHSASAK1KA	
12.5 HP	25.31 A	14.61 A	13.2 A - 20 A	20 A	IHSASAL1KA	24970.00
15 HP ▲	30.38 A	17.54 A	13.2 A - 20 A	20 A	IHSASAL1KB	25510.00
17.5 HP	35.44 A	20.46 A	17.4 A - 24 A	25 A	IHSASAM1KA	
20 HP ▲	40.50 A	23.38 A	22 A - 30 A	32 A	IHSASAN1KA	29220.00

▲ Stockable Item

For details on technical parameters & non stockable items contact nearest sales office.

Features:

- Water Filled / Oil Filled Submersible motor Configuration
- Digital Smart display for clear identification of current and voltage
- OLP, MCB & contactor combination for better efficiency & performance against product safety
- Inbuilt Dry run protection
- Applicable for 75 mm / 100 mm borewell Submersible Pump application
- Suitable for wide voltage operation
- High quality rubber gasket to prevent dusty entry
- Five-way connector for easy connection



HSN Code: 85369010

Item Code	kW	HP	Type	Descriptions	OLP	MCB	Con-tactor	Run Capacitor $\mu$ F (MFD)	Start Capacitor $\mu$ F (MFD)	Per Unit LP (₹)
IHQMFDM1F1	0.37 kW	0.5 HP	water Filled	0.5 HP SP STR WATER FILLED R6A	6 A	10 A	20 A	36 $\mu$ F	120 $\mu$ F - 150 $\mu$ F	4065.00
IHRMFDM1F1	0.37 kW	0.5 HP	Oil Filled	0.5 HP SP STR OIL FILLED R6A	6 A	10 A	20 A	36 $\mu$ F	-	3795.00
IHQMFQ1F1	0.75 kW	1 HP ▲	water Filled	1 HP SP STR WATER FILLED R 10A	10 A	16 A	20 A	50 $\mu$ F	120 $\mu$ F - 150 $\mu$ F	4150.00
IHRMFQ1F1	0.75 kW	1 HP	Oil Filled	1 HP SP STR OIL FILLED R10A	10 A	16 A	20 A	36 $\mu$ F	-	4015.00
IHSMFDQ1F1	0.75 kW	1 HP	Oil Filled	1 HP SP STR OIL FILLED WC R10A	10 A	16 A	0 A	36 $\mu$ F	-	2275.00
IHQMFDR1F1	1.1 kW	1.5 HP ▲	water Filled	1.5 HP SP STR WATER FILLED R 12A	16 A	20 A	25 A	72 $\mu$ F	150 $\mu$ F - 200 $\mu$ F	4490.00
IHRMFDR1F1	1.1 kW	1.5 HP	Oil Filled	1.5 HP SP STR OIL FILLED R12A	16 A	20 A	25 A	50 $\mu$ F	-	4260.00
IHSMFDR1F1	1.1 kW	1.5 HP	Oil Filled	1.5 HP SP STR OIL FILLED WC R12A	12 A	20 A	0 A	50 $\mu$ F	-	2405.00
IHQMFDT1FA	1.1 kW	1.5 HP	Water Filled	1.5 HP SP STR WATER FILLED R14A	16 A	20 A	25 A	(50+50) $\mu$ F	150 $\mu$ F - 200 $\mu$ F	4585.00
IHQMFDU1F1	1.5 kW	2 HP ▲	Water Filled	2 HP SP STR WATER FILLED R 16A	16 A	20 A	25 A	72 $\mu$ F	150 $\mu$ F - 200 $\mu$ F	4685.00
IHQMFDU1FA	1.5 kW	2 HP	Water Filled	2 HP SP STR WATER FILLED R16A CAP 50+50	16 A	20 A	25 A	(50+50) $\mu$ F	150 $\mu$ F - 200 $\mu$ F	4780.00
IHRMFDU1F1	1.5 kW	2 HP	Oil Filled	2 HP SP STR OIL FILLED R16A	16 A	20 A	25 A	72 $\mu$ F	-	4485.00
IHQMFV1F1	2.2 kW	3 HP	water Filled	3 HP SP STR WATER FILLED R 25A	25 A	32 A	32 A	(50+50) $\mu$ F	200 $\mu$ F - 250 $\mu$ F	5405.00

Features:

- Inbuilt start run capacitor
- Suitable for wide voltage operation
- High quality rubber gasket to prevent dusty entry
- Five-way connector for easy connection
- OLR with Single Phasing Protection



HSN Code: 85369010

HP Rating	kW	Overload Relay (A)	Contactor (A)	Start Capacitor $\mu$ F (MFD)	Run Capacitor $\mu$ F (MFD)	Item Code	List Price in (₹) Per Unit
0.5 HP	0.37 kW	3.8 A - 6.0 A	20 A	80 $\mu$ F - 100 $\mu$ F	25 $\mu$ F	IHADOAH1F1	6350.00
0.5 HP	0.37 kW	3.8 A - 6.0 A	20 A	80 $\mu$ F - 100 $\mu$ F	36 $\mu$ F	IHADOAJ1FA	
1 HP	0.75 kW	6 A - 9.3 A	20 A	100 $\mu$ F - 120 $\mu$ F	36 $\mu$ F	IHADOAJ1FB	
1 HP ▲	0.75 kW	6 A - 9.3 A	20 A	100 $\mu$ F - 120 $\mu$ F	50 $\mu$ F	IHADOAJ1FC	
1 HP	0.75 kW	6 A - 9.3 A	20 A	120 $\mu$ F - 150 $\mu$ F	50 $\mu$ F	IHADOAJ1FD	7005.00
1.5 HP ▲	1.1 kW	8.9 A - 13.5 A	20 A	120 $\mu$ F - 150 $\mu$ F	50 $\mu$ F	IHADOAK1FA	
1.5 HP ▲	1.1 kW	8.9 A - 13.5 A	20 A	150 $\mu$ F - 200 $\mu$ F	(36+36) $\mu$ F	IHADOAK1FB	7490.00
2 HP ▲	1.5 kW	13.2 A - 20 A	20 A	150 $\mu$ F - 200 $\mu$ F	(36+36) $\mu$ F	IHADOAL1FA	
2 HP ▲	1.5 kW	13.2 A - 20 A	20 A	150 $\mu$ F - 200 $\mu$ F	(50+50) $\mu$ F	IHADOAL1FB	
2 HP ▲	1.5 kW	13.2 A - 20 A	20 A	200 $\mu$ F - 250 $\mu$ F	(50+36) $\mu$ F	IHADOAL1FC	8875.00
3 HP ▲	2.2 kW	17.4 A - 24 A	25 A	200 $\mu$ F - 250 $\mu$ F	(50+50) $\mu$ F	IHADOAM1FA	
3 HP ▲	2.2 kW	17.4 A - 24 A	25 A	200 $\mu$ F - 250 $\mu$ F	(50+36+36) $\mu$ F	IHADOAM1FB	

▲ Stockable Item

For details on technical parameters & non stockable items contact nearest sales office.

Effective from 1st April, 2026

List Price (LP) are in Indian ₹ & as per Standard Terms & Conditions **HAVELLS 75**

## urja Contactor 4 Pole (16 A to 40 A)



### Features:

- Rugged Contactors with heavy duty Contacts with anti-welding silver alloys
- High Mechanical and Electrical Life
- High Terminal Capacity
- Suitable for Wide voltage Fluctuations including sudden DIP in voltage

HSN Code: 85369010

AC-3 Duty Rating at 415 V, 50 Hz Ie (A)	AC-1 Duty Rating at 415 V, 50 Hz Ith (A)	Power Poles	Type	Item Code	Item Description	Per Unit LP (₹)
20 A	25 A	4	UC1 20 F	IHPBC020100*	20 A 4P Contactor	3710.00
25 A	40 A		UC1 25 F	IHPBC025100*	25 A 4P Contactor	4580.00
32 A	45 A		UC1 32 F	IHPBC032100*	32 A 4P Contactor	5200.00
40 A	63 A		UC1 40 F	IHPBC040100*	40 A 4P Contactor	6800.00

## urja Contactor 2 Pole (16 A to 40 A)



### Features:

- Rugged Contactors with heavy duty Contacts with anti-welding silver alloys
- High Mechanical and Electrical Life
- High Terminal Capacity
- Suitable for Wide voltage Fluctuations including sudden DIP in voltage

HSN Code: 85369010

AC-3 Duty Rating at 415 V, 50 Hz Ie (A)	AC-1 Duty Rating at 415 V, 50 Hz Ith (A)	Power Poles	Type	Item Code	Item Description	Per Unit LP (₹)
20 A	32 A	2	UC1 20 D	IHPBF020100*	20 A 2P Contactor	1780.00
25 A	40 A		UC1 25 D	IHPBF025100*	25 A 2P Contactor	2535.00
40 A	63 A		UC1 40 D	IHPBF040100*	40 A 2P Contactor	3475.00

\*To complete the Cat no. suffix the coil voltage from the coil voltage table

### AC Coil for 4 Pole

Code*	F	K
AC Voltage	140 V - 270 V	260 V - 440 V

### AC Coil for 2 Pole

Code*	F
AC Voltage	140 V - 270 V



## urja Thermal Overload Relay 3 Pole

HSN Code: 85364900

Relay Range (A)	Suitable for	Poles	Type	Item Code	Item Description	Per Unit LP (₹)
1.07 A - 1.7 A	4 Pole Contactors	3	UR1 E	IHAR13CE	3P Thermal O/L Relay A/M	2580.00
1.58 A - 2.5 A			UR1 F	IHAR13CF	3P Thermal O/L Relay A/M	
2.4 A - 3.8 A			UR1 G	IHAR13CG	3P Thermal O/L Relay A/M	
3.8 A - 6.0 A			UR1 H	IHAR13CH	3P Thermal O/L Relay A/M	
6 A - 9.3 A			UR1 J	IHAR13CJ	3P Thermal O/L Relay A/M	
8.9 A - 13.5 A			UR1 K	IHAR13CK	3P Thermal O/L Relay A/M	
13.2 A - 20 A			UR1 L	IHAR13CL	3P Thermal O/L Relay A/M	
17.4 A - 24 A			UR1 M	IHAR13CM	3P Thermal O/L Relay A/M	
22 A - 30 A			UR1 N	IHAR13CN	3P Thermal O/L Relay A/M	

## urja Thermal Overload Relay 2 Pole



HSN Code: 85364900

Relay Range (A)	Suitable for	Poles	Type	Item Code	Item Description	Per Unit LP (₹)
3.8 A - 6 A	2 Pole Contactors	2	UR1 H	IHAR12CH	2P Thermal O/L Relay A/M	1260.00
6 A - 9.3 A			UR1 J	IHAR12CJ	2P Thermal O/L Relay A/M	
8.9 A - 13.5 A			UR1 K	IHAR12CK	2P Thermal O/L Relay A/M	
13.2 A - 20 A			UR1 L	IHAR12CL	2P Thermal O/L Relay A/M	1375.00
17.4 A - 24 A			UR1 M	IHAR12CM	2P Thermal O/L Relay A/M	
22 A - 30 A			UR1 N	IHAR12CN	2P Thermal O/L Relay A/M	

▲ Stockable Item

For details on technical parameters & non stockable items contact nearest sales office.

**Spare Agri Contactor 2P / 4P**

HSN Code: 85389000

Type	Rating	Item Code	Per Unit LP (₹)
Housing 2P		ISCPMPXCX016	435.00
Housing 4P		ISCPMPXCX014	700.00
Carrier Assembly 2P		ISSPEX0447	130.00
Carrier Assembly 4P		ISSPEX0446	180.00
2P Contactor Coil	140 V - 270 V	ISSPEP0008	930.00
4P Contactor Coil	200 V - 400 V	ISSPEP0007	1065.00
	415 V (260 V - 440 V)	ISSPEP0009	
	240 V (140 V - 270 V)	ISSPEP0011	
Single Fixed Contact 2P / 4P	20 A	ISSPEX0428	150.00
	25 A	ISSPEX0429	200.00
	32 A	ISSPEX0430	210.00
	40 A	ISSPEX0439	260.00
Single Moving Contact 2P / 4P	20 A	ISSPEX0431	220.00
	25 A	ISSPEX0432	315.00
	32 A	ISSPEX0433	355.00
	40 A	ISSPEX0440	435.00
Contact Kit 2P Contactor	20 A	ISSPEX0441	1000.00
	25 A	ISSPEX0442	1400.00
	40 A	ISSPEX0444	1845.00
Contact Kit 4P Contactor	20 A	ISSPEX0434	1810.00
	25 A	ISSPEX0435	2810.00
	32 A	ISSPEX0436	3025.00
	40 A	ISSPEX0445	3015.00



▲ Stockable Item  
For details on technical parameters & non stockable items contact nearest sales office.

**DOL Starter - Spares**

HSN Code: 85389000

Type	Item Code	Per Unit LP (₹)
NO Switch URJA	ISSPEX0437	210.00
ON / OFF Push Button Assembly URJA	ISSPEX0438	



**urja** Single Phase Sub. Starter - Spares

HSN Code: 85389000

Type	Item Code	Per Unit LP (₹)
PB Red for SPSS with 1NC Element	ISCELXLX0001	315.00
5+16 Element (1.5-2 HP) 1.12 kW - 1.50 kW	ISCELXLX0002	590.00
	5+25 Element (3-5 HP) 2.24 kW - 3.73 kW	ISCELXLX0003
Neon Light Indicator Red	ISCELKLX0006	130.00
Front Add-on Aux.Cont.Blck	2NO ISSPEX0427	670.00
Combined AV Meter	30 A - 300 V ISCELMLX0006	1770.00
	25 A - 500 V ISCELMLX0007	1785.00
	50 A - 500 V ISCELMLX0008	1950.00
Terminal Block	2 Way SPSS ISCPMPSX032	75.00
	5 Way ISCELXPX0003	250.00



▲ Stockable Item  
For details on technical parameters & non stockable items contact nearest sales office.

Type	Item Code	Per Unit LP (₹)
Start Push Button - Green	ICELL00002	280.00
Stop Push Button - Red	ICELL00003	
Motor ON Indicating Light-Green	ICELKL00015	440.00
Motor Trip Indicating Light-Yellow	ICELKL00013	
SPP	ISCELXL00063	4675.00
Combined Voltmeter & Ammeter	ISCELMLX0007	1785.00
Terminal Block 6 way	ICELPSMX001	675.00
Terminal Block 3 way	ICELPSMX002	410.00
VOLT.SEL SW. C/G	ICELQL00021	625.00
Electronic Timer	ICELRPSL005	4030.00
Front Block 1NO 1NC	ISPNAFM711	705.00
Mini Rocker Switch - SPP By Pass	ISCELEL00218	72.00



▲ Stockable Item  
For details on technical parameters & non stockable items contact nearest sales office.

# Street Light Panel



## Street Light Panel

### Features:

- Range : 6 kW to 12 kW
- Conforms to IS/IEC 61439 & 60529
- Provided with Protection Degree IP54
- Extended wide band coil
- FRLS (Fire retardant low smoke) Internal wiring
- In-built Short-Circuit Protection
- Class H Insulation

HSN Code: 85365090

Phase	Max. Load (kW)	Contactor Rating (A)	MCB Rating	Digital 24 Hour Switch		Astronomical Switch	
				Item Code	Per Unit	Item Code	Per Unit LP (₹)
3	6 kW	32 A TP	40 A TPN	IHXTS03060	44300.00	IHXTS0306A	45650.00
	12 kW	65 A TP	63 A TPN	IHXTS09120	68360.00	IHXTS0912A	69700.00
1	2 kW	20 A DP	16 A SPN	IHXSS01020	25370.00	IHXSS01020A	26570.00
	6 kW	32 A TP	40 A SPN	IHXSS01060	33220.00	IHXSS0106A	34570.00
	12 kW	65 A TP	63 A SPN	IHXSS03120	49910.00	IHXSS0312A	51260.00

HSN Code: 85389000

Description	Item Code	Per Unit LP (₹)
PROGRAMMABLE TIME SWITCH FOR SLP	ISCELMLX0012	4860.00
ASTRONOMICAL TIME SWITCH FOR SLP	ISCELMLX0013	5260.00

For customised Street Lighting Panels, contact to nearest branch

▲ Stockable Item

For details on technical parameters & non stockable items contact nearest sales office.

# Power Quality Solutions



# Power Quality Solutions

## MPP Power Capacitor



### Power Capacitors

Parameters	Splendid Duty	Heavy Duty Plus / Heavy Duty	Super Heavy Duty (double dielectric) / Super Heavy Duty
Type	MPP	MPP	MPP
Over Current withstand capacity upto	1.6 X Ir	2.4 X Ir	3.2 X Ir / 3.0 X Ir
Peak Inrush Current Withstand Capacity upto	250 times	350 times / 350 times	500 times / 500 times
Total Losses	≤0.45 W / kVAr	≤0.45 W / kVAr	≤0.45 W / kVAr
No of switching per year	35000	52500 / 45000	80000 / 65000
Max Ambient Temp (°C)	55 °C	55 °C	55 °C
Operating life in hours	120000 hours	215000 hours / 150000 hours	300000 hours / 250000 hours
Notch Shield	Yes	Yes	Yes
Over pressure Disconnecter	Yes	Yes	Yes
Triple Safety	Yes	Yes	Yes
Certification	ISI Marked		
Conforms to standard	IS: 13340 / IEC: 60831		

### Selection of Capacitor

Selection of Capacitor Type is first decision to be made  
 Power Factor Correction Capacitor can be classified as follows.  
 Splendid Duty - Torrent and Mini Master / Master  
 Heavy Duty - Phantom & Champ  
 SHD / UHDXL- Warrior and Champion (Double Di-electric)

### Refer following table for the capacitor duty based on type of Industry / Application

Power Capacitor Selection Chart on the basis of Application				
% Non linear load	≤ 10%	Up to 15%	Up to 20%	Between 20% to 30%
Square	Master Splendid Duty	Champ HD Plus	Champion SHD	Champ HD Plus + Reactor
Cylindrical	Torrent Splendid Duty	Phantom HD	Warrior SHD	Warrior SHD + Reactor
Application	These Capacitors are designed for normal loads where non linear factor is ≤10% THD I. Do not use normal duty capacitors for the application of Heavy Duty and Super Heavy Duty capacitors.	<15% THD I. Commercial building with CFL lamps, SMPS, UPS etc.	<20% THD I. Heavy Chemical Industries	<25% THD I. Steel plant
		Garment industries (Sewing Industry)	Pharmaceutical Industries	Cement Industries
		Bakeries	Automobile plants	Stone crushing
		Flour mills	Paper Industries	Textiles (Production of Yarn/cloth)
		Oil mills	Food processing plants	Forging Industries
		Glass industries	IT Industries	Power frequency induction furnaces
		Rice mills	Fabrication shops	Sugar plants
		Cold storage	Welding shops	Rolling mills
		Machine and tool shop		
Example for Calculating Non Linear Load Installed Transformer Rating = 1000 kVA Non Linear Loads = 100 kVA $\% \text{ Non Linear Load} = (\text{Non Linear Load} / \text{Transformer Rating}) \times 100$ $= (100/1000) \times 100$ $= 10\%$				
Example of Non Linear Loads: UPS, Arc / Induction furnace, Rectifiers, AC / DC Drives, Computer, CFL, CNC Machines.				

# Calculation of Required kVAr

Current Power Factor Cos φ	Achievable (Target) Cos φ					Target Cos φ = 0.96	Q				
	0.90	0.91	0.92	0.94	0.95	0.96		0.97	0.98	0.99	1
0.51	1.20	1.23	1.26	1.32	1.36	1.40		1.44	1.48	1.54	1.69
0.52	1.16	1.19	1.22	1.28	1.31	1.35		1.39	1.44	1.50	1.64
0.53	1.11	1.14	1.17	1.24	1.27	1.30		1.35	1.40	1.46	1.60
0.54	1.08	1.10	1.13	1.20	1.23	1.27		1.31	1.36	1.42	1.56
0.55	1.04	1.06	1.09	1.16	1.19	1.23		1.27	1.32	1.38	1.52
0.56	1.00	1.02	1.05	1.12	1.15	1.19		1.23	1.28	1.34	1.48
0.57	0.96	0.99	1.02	1.08	1.11	1.15		1.19	1.24	1.30	1.44
0.58	0.92	0.95	0.98	1.04	1.08	1.11		1.15	1.20	1.26	1.41
0.59	0.89	0.91	0.94	1.01	1.04	1.08		1.12	1.17	1.23	1.37
0.60	0.85	0.88	0.91	0.97	1.00	1.04		1.08	1.13	1.19	1.33
0.61	0.82	0.84	0.87	0.94	0.97	1.01		1.05	1.10	1.16	1.30
0.62	0.78	0.81	0.84	0.90	0.94	0.97		1.02	1.06	1.12	1.27
0.63	0.75	0.78	0.81	0.87	0.90	0.94		0.98	1.03	1.09	1.23
0.64	0.72	0.75	0.78	0.84	0.87	0.91		0.95	1.00	1.07	1.20
0.65	0.69	0.71	0.74	0.81	0.84	0.88		0.92	0.97	1.03	1.17
0.66	0.65	0.68	0.71	0.77	0.81	0.85		0.89	0.94	1.00	1.14
0.67	0.62	0.65	0.68	0.74	0.78	0.82		0.86	0.91	0.97	1.11
0.68	0.59	0.62	0.65	0.71	0.75	0.79		0.83	0.88	0.94	1.08
0.69	0.57	0.59	0.62	0.68	0.72	0.76		0.80	0.85	0.91	1.05
0.70	0.54	0.56	0.59	0.65	0.69	0.73		0.77	0.82	0.88	1.02
0.71	0.51	0.54	0.57	0.63	0.66	0.70		0.74	0.79	0.85	0.99
0.72	0.48	0.51	0.54	0.60	0.64	0.67		0.71	0.76	0.82	0.96
0.73	0.45	0.48	0.51	0.57	0.61	0.64		0.69	0.73	0.79	0.94
0.74	0.43	0.45	0.48	0.54	0.58	0.62		0.66	0.71	0.77	0.91
0.75	0.40	0.43	0.46	0.51	0.55	0.59		0.63	0.68	0.74	0.88
0.76	0.37	0.40	0.43	0.49	0.53	0.56		0.60	0.65	0.71	0.86
0.77	0.35	0.37	0.40	0.46	0.50	0.44		0.58	0.63	0.69	0.83
0.78	0.32	0.35	0.38	0.43	0.47	0.51		0.55	0.60	0.66	0.80
0.79	0.29	0.32	0.35	0.41	0.45	0.48		0.53	0.57	0.63	0.78
0.80	0.27	0.29	0.32	0.38	0.42	0.46		0.50	0.55	0.61	0.75
0.81	0.24	0.27	0.30	0.36	0.40	0.43		0.47	0.52	0.58	0.72
0.82	0.21	0.24	0.27	0.33	0.37	0.41		0.45	0.50	0.56	0.70
0.83	0.19	0.22	0.25	0.30	0.34	0.38		0.42	0.47	0.53	0.67
0.84	0.16	0.19	0.22	0.28	0.32	0.35		0.40	0.44	0.50	0.65
0.85	0.14	0.16	0.19	0.25	0.29	0.33		0.37	0.42	0.48	0.62
0.86	0.11	0.14	0.17	0.23	0.26	0.30		0.34	0.39	0.45	0.59
0.87	0.08	0.11	0.14	0.20	0.24	0.28		0.32	0.36	0.43	0.57
0.88	0.06	0.08	0.11	0.17	0.21	0.25		0.29	0.34	0.40	0.54
0.89	0.03	0.06	0.09	0.15	0.18	0.22		0.26	0.31	0.37	0.51
0.90	0.00	0.03	0.08	0.12	0.16	0.19		0.23	0.28	0.34	0.48
0.91		0.00	0.03	0.09	0.13	0.16		0.21	0.25	0.31	0.46
0.92			0.00	0.06	0.10	0.13		0.18	0.22	0.28	0.43
0.93				0.03	0.07	0.10		0.14	0.19	0.25	0.40
0.94				0.00	0.03	0.07		0.11	0.16	0.22	0.36
0.95					0.00	0.04		0.08	0.13	0.19	0.33

### Calculation of Required kVAr

Operating load kW and its average power factor (PF) as per the electricity bill OR we can easily calculate by a simple formula

Average PF = kW / kVA Operating load kW = kVA Demand x Average PF

Average PF is considered as the initial PF and the final PF is assumed as a target PF. From this information required kVAr can be easily calculated with reference table.

Example: Calculate required kVAr to improve PF from 0.75 to 0.96 for 500 kW installation

kVAr = kW x multiplying factor from table = 500 x 0.590 = 295 kVAr

## Hercules - Normal Duty Single Phase Cylindrical Capacitors

- Design in Cylindrical Aluminium cane.
- Output range 1 kVAr to 5 kVAr.
- Compact volume, low weight
- Easy connection and installation



HSN Code: 85321000

Rating kVAr	Item Code	Description	Standard Pack No of unit/s	Master Pack No of unit/s	Per Unit LP (₹)
<b>Rated Voltage 250 V AC, 1<math>\phi</math>, 50 Hz</b>					
1 kVAr	QHBS5001X0	HERCULES 250 V 50 Hz-1 kVAr 1 PH	1 N	16 N	541.00
2 kVAr	QHBS5002X0	HERCULES 250 V 50 Hz-2 kVAr 1 PH	1 N	16 N	750.00
3 kVAr	QHBS5003X0	HERCULES 250 V 50 Hz-3 kVAr 1 PH	1 N	16 N	1129.00
4 kVAr	QHBS5004X0	HERCULES 250 V 50 Hz-4 kVAr 1 PH	1 N	16 N	1488.00
5 kVAr	QHBS5005X0	HERCULES 250 V 50 Hz-5 kVAr 1 PH	1 N	8 N	1836.00

## Torrent - Splendid Duty Cylindrical Capacitors

- Design in Cylindrical Aluminium cane.
- Output range 1 kVAr to 30 kVAr.
- Long life expectancy upto 120000 Hours
- Compact volume, low weight
- Easy connection and installation



HSN Code: 85321000

Rating kVAr	Item Code	Description	Standard Pack No of unit/s	Master Pack No of unit/s	Per Unit LP (₹)
<b>Rated Voltage 440 V AC, 3<math>\phi</math>, 50 Hz, Delta Connection</b>					
1 kVAr ▲	QHUTCC5001X0	Torrent 440 V 50 Hz-1 kVAr 3 PH	1 N	16 N	419.00
2 kVAr ▲	QHUTCC5002X0	Torrent 440 V 50 Hz-2 kVAr 3 PH	1 N	16 N	638.00
3 kVAr ▲	QHUTCC5003X0	Torrent 440 V 50 Hz-3 kVAr 3 PH	1 N	16 N	997.00
4 kVAr ▲	QHUTCC5004X0	Torrent 440 V 50 Hz-4 kVAr 3 PH	1 N	16 N	1103.00
5 kVAr ▲	QHUTCC5005X0	Torrent 440 V 50 Hz-5 kVAr 3 PH	1 N	16 N	1264.00
6 kVAr ▲	QHUTCC5006X0	Torrent 440 V 50 Hz-6 kVAr 3 PH	1 N	16 N	1514.00
7.5 kVAr ▲	QHUTCC5007X5	Torrent 440 V 50 Hz-7.5 kVAr 3PH	1 N	16 N	1898.00
10 kVAr ▲	QHUTCC5010X0	Torrent 440 V 50 Hz-10 kVAr 3 PH	1 N	8 N	2528.00
12.5 kVAr ▲	QHUTCC5012X5	Torrent 440 V 50 Hz-12.5 kVAr 3 PH	1 N	8 N	3157.00
15 kVAr ▲	QHUTCC5015X0	Torrent 440 V 50 Hz-15 kVAr 3 PH	1 N	4 N	3786.00
20 kVAr ▲	QHUTCC5020X0	Torrent 440 V 50 Hz-20 kVAr 3 PH	1 N	4 N	5050.00
25 kVAr ▲	QHUTCC5025X0	Torrent 440 V 50 Hz-25 kVAr 3 PH	1 N	4 N	6308.00
30 kVAr	QHUTCC5030X0	Torrent 440 V 50 Hz-30 kVAr 3 PH	1 N	4 N	7572.00

## Phantom - Heavy Duty Cylindrical Capacitors

- Design in Cylindrical Aluminium Cane.
- Output range - 1 kVAr to 50 kVAr
- High Inrush Current Withstand Capability
- Operating Life in Hrs - 150000
- Soft Sticky Resin to withstand high temperature and current stress



HSN Code: 85321000

Rating kVAr	Item Code	Description	Standard Pack No of unit/s	Master Pack No of unit/s	Per Unit LP (₹)
<b>Rated Voltage 440 V AC, 3<math>\phi</math>, 50 Hz, Delta Connection</b>					
1 kVAr ▲	QHHTCC5001X0	PHANTOM HD 440 V 50 Hz 1 kVAr 3 PH	1 N	16 N	514.00
2 kVAr ▲	QHHTCC5002X0	PHANTOM HD 440 V 50 Hz 2 kVAr 3 PH	1 N	16 N	783.00
3 kVAr ▲	QHHTCC5003X0	PHANTOM HD 440 V 50 Hz 3 kVAr 3 PH	1 N	16 N	1082.00
4 kVAr ▲	QHHTCC5004X0	PHANTOM HD 440 V 50 Hz 4 kVAr 3 PH	1 N	16 N	1295.00
5 kVAr ▲	QHHTCC5005X0	PHANTOM HD 440 V 50 Hz 5 kVAr 3 PH	1 N	16 N	1628.00
7.5 kVAr ▲	QHHTCC5007X5	PHANTOM HD 440 V 50 Hz 7.5 kVAr 3 PH	1 N	16 N	2314.00
10 kVAr ▲	QHHTCC5010X0	PHANTOM HD 440 V 50 Hz 10 kVAr 3 PH	1 N	16 N	3079.00
12.5 kVAr ▲	QHHTCC5012X5	PHANTOM HD 440 V 50 Hz 12.5 kVAr 3 PH	1 N	8 N	3854.00
15 kVAr ▲	QHHTCC5015X0	PHANTOM HD 440 V 50 Hz 15 kVAr 3 PH	1 N	8 N	4623.00
20 kVAr ▲	QHHTCC5020X0	PHANTOM HD 440 V 50 Hz 20 kVAr 3 PH	1 N	4 N	6162.00
25 kVAr ▲	QHHTCC5025X0	PHANTOM HD 440 V 50 Hz 25 kVAr 3 PH	1 N	4 N	7696.00
30 kVAr	QHHTCC5030X0	PHANTOM HD 440 V 50 Hz 30 kVAr 3 PH	1 N	4 N	9241.00
50 kVAr	QHHTCC5050X0	PHANTOM HD 440 V 50 Hz 50 kVAr 3 PH	1 N	4 N	15392.00

▲ Stockable Item

For details on technical parameters & non stockable items contact nearest sales office.

(IS: 13340 / IEC: 60831)

# Warrior - Super Heavy Duty Cylindrical Capacitors

- High inrush current withstand capability.
- Output range 1 kVAr to 30 kVAr.
- Soft sticky resin to withstand high temperature and current stress.
- Penta safety protection.
- Explosion proof, low losses & high over current withstand capabilities.



HSN Code: 85321000

Rating kVAr	Item Code	Description	Standard Pack No of unit/s	Master Pack No of unit/s	Per Unit LP (₹)
<b>Rated Voltage 440 V AC, 3<math>\phi</math>, 50 Hz, Delta Connection</b>					
1 kVAr ▲	QHBTCC5001X0	Warrior Super Heavy Duty 440 V 50 Hz 1 kVAr 3 PH	1 N	16 N	546.00
2 kVAr ▲	QHBTCC5002X0	Warrior Super Heavy Duty 440 V 50 Hz 2 kVAr 3 PH	1 N	16 N	830.00
3 kVAr ▲	QHBTCC5003X0	Warrior Super Heavy Duty 440 V 50 Hz 3 kVAr 3 PH	1 N	16 N	1034.00
4 kVAr ▲	QHBTCC5004X0	Warrior Super Heavy Duty 440 V 50 Hz 4 kVAr 3 PH	1 N	16 N	1384.00
5 kVAr ▲	QHBTCC5005X0	Warrior Super Heavy Duty 440 V 50 Hz 5 kVAr 3 PH	1 N	16 N	1794.00
6 kVAr	QHBTCC5006X0	Warrior Super Heavy Duty 440 V 50 Hz 7.5 kVAr 3 PH	1 N	8 N	2148.00
7.5 kVAr ▲	QHBTCC5007X5	Warrior Super Heavy Duty 440 V 50 Hz 6 kVAr 3 PH	1 N	8 N	2684.00
8 kVAr	QHBTCC5008X0	Warrior Super Heavy Duty 440 V 50 Hz 8 kVAr 3 PH	1 N	8 N	2866.00
10 kVAr ▲	QHBTCC5010X0	Warrior Super Heavy Duty 440 V 50 Hz 10 kVAr 3 PH	1 N	8 N	3578.00
12.5 kVAr ▲	QHBTCC5012X5	Warrior Super Heavy Duty 440 V 50 Hz 12.5 kVAr 3 PH	1 N	4 N	4472.00
15 kVAr ▲	QHBTCC5015X0	Warrior Super Heavy Duty 440 V 50 Hz 15 kVAr 3 PH	1 N	4 N	5367.00
20 kVAr ▲	QHBTCC5020X0	Warrior Super Heavy Duty 440 V 50 Hz 20 kVAr 3 PH	1 N	4 N	7156.00
25 kVAr ▲	QHBTCC5025X0	Warrior Super Heavy Duty 440 V 50 Hz 25 kVAr 3 PH	1 N	4 N	8944.00
30 kVAr	QHBTCC5030X0	Warrior Super Heavy Duty 440 V 50 Hz 30 kVAr 3 PH	1 N	4 N	10733.00
<b>Rated Voltage 480 V AC, 3<math>\phi</math>, 50 Hz, Delta Connection</b>					
5 kVAr	QHBTCD5005X0	Warrior Super Heavy Duty 480 V 50 Hz 5 kVAr 3 PH	1 N	16 N	1846.00
7.5 kVAr	QHBTCD5007X5	Warrior Super Heavy Duty 480 V 50 Hz 7.5 kVAr 3 PH	1 N	8 N	2777.00
10 kVAr	QHBTCD5010X0	Warrior Super Heavy Duty 480 V 50 Hz 10 kVAr 3 PH	1 N	8 N	3698.00
12.5 kVAr	QHBTCD5012X5	Warrior Super Heavy Duty 480 V 50 Hz 12.5 kVAr 3 PH	1 N	4 N	4618.00
15 kVAr	QHBTCD5015X0	Warrior Super Heavy Duty 480 V 50 Hz 15 kVAr 3 PH	1 N	4 N	5538.00
20 kVAr	QHBTCD5020X0	Warrior Super Heavy Duty 480 V 50 Hz 20 kVAr 3 PH	1 N	4 N	7379.00
25 kVAr	QHBTCD5025X0	Warrior Super Heavy Duty 480 V 50 Hz 25 kVAr 3 PH	1 N	4 N	9230.00
30 kVAr	QHBTCD5030X0	Warrior Super Heavy Duty 480 V 50 Hz 30 kVAr 3 PH	1 N	4 N	11076.00
<b>Rated Voltage 525 V AC, 3<math>\phi</math>, 50 Hz, Delta Connection</b>					
5 kVAr	QHBTCF5005X0	Warrior Super Heavy Duty 525 V 50 Hz 5 kVAr 3 PH	1 N	16 N	1846.00
7.5 kVAr	QHBTCF5007X5	Warrior Super Heavy Duty 525 V 50 Hz 7.5 kVAr 3 PH	1 N	8 N	2777.00
10 kVAr	QHBTCF5010X0	Warrior Super Heavy Duty 525 V 50 Hz 10 kVAr 3 PH	1 N	8 N	3698.00
12.5 kVAr	QHBTCF5012X5	Warrior Super Heavy Duty 525 V 50 Hz 12.5 kVAr 3 PH	1 N	4 N	4618.00
15 kVAr	QHBTCF5015X0	Warrior Super Heavy Duty 525 V 50 Hz 15 kVAr 3 PH	1 N	4 N	5538.00
20 kVAr	QHBTCF5020X0	Warrior Super Heavy Duty 525 V 50 Hz 20 kVAr 3 PH	1 N	4 N	7379.00
25 kVAr	QHBTCF5025X0	Warrior Super Heavy Duty 525 V 50 Hz 25 kVAr 3 PH	1 N	4 N	9230.00
30 kVAr	QHBTCF5030X0	Warrior Super Heavy Duty 525 V 50 Hz 30 kVAr 3 PH	1 N	4 N	11076.00

▲ Stockable Item

For details on technical parameters & non stockable items contact nearest sales office.

(IS: 13340 / IEC: 60831)

Effective from 1st April, 2026

List Price (LP) are in Indian ₹ & as per Standard Terms & Conditions **HAVELLS 85**

## Mini / Master - Splendid Duty Square Capacitors

- High inrush current withstand capability.
- Output range 1 kVAr to 50 kVAr.
- Soft sticky resin to withstand high temperature and current stress.
- Penta safety protection.
- Explosion proof, low losses & high over current withstand capabilities.



HSN Code: 85321000

Rating kVAr	Item Code	Description	Standard Pack No of unit/s	Master Pack No of unit/s	Per Unit LP (₹)
<b>Rated Voltage 440 V AC, 3<math>\phi</math>, 50 Hz, Delta Connection</b>					
1 kVAr ▲	QHNTMC5001X0	Mini Master 440 V 50 Hz-1 kVAr 3 PH	1 N	30 N	509.00
2 kVAr ▲	QHNTMC5002X0	Mini Master 440 V 50 Hz-2 kVAr 3 PH	1 N	30 N	691.00
3 kVAr ▲	QHNTMC5003X0	Mini Master 440 V 50 Hz-3 kVAr 3 PH	1 N	24 N	1034.00
4 kVAr ▲	QHNTMC5004X0	Mini Master 440 V 50 Hz-4 kVAr 3 PH	1 N	24 N	1378.00
5 kVAr ▲	QHNTMC5005X0	Mini Master 440 V 50 Hz-5 kVAr 3 PH	1 N	24 N	1607.00
6 kVAr ▲	QHNTMC5006X0	Master 440 V 50 Hz-6 kVAr 3 PH	1 N	1 N	1930.00
7.5 kVAr ▲	QHNTMC5007X5	Master 440 V 50 Hz-7.5 kVAr 3 PH	1 N	1 N	2403.00
8 kVAr ▲	QHNTMC5008X0	Master 440 V 50 Hz-8 kVAr 3 PH	1 N	1 N	2564.00
10 kVAr ▲	QHNTMC5010X0	Master 440 V 50 Hz-10 kVAr 3 PH	1 N	1 N	3209.00
12.5 kVAr ▲	QHNTMC5012X5	Master 440 V 50 Hz-12.5 kVAr 3 PH	1 N	1 N	4010.00
15 kVAr ▲	QHNTMC5015X0	Master 440 V 50 Hz-15 kVAr 3 PH	1 N	1 N	4810.00
20 kVAr ▲	QHNTMC5020X0	Master 440 V 50 Hz-20 kVAr 3 PH	1 N	1 N	6412.00
25 kVAr ▲	QHNTMC5025X0	Master 440 V 50 Hz-25 kVAr 3 PH	1 N	1 N	8014.00
30 kVAr	QHNTMC5030X0	Master 440 V 50 Hz-30 kVAr 3 PH	1 N	1 N	9615.00
50 kVAr	QHNTMC5050X0	Master 440 V 50 Hz-50 kVAr 3 PH	1 N	1 N	16027.00

▲ Stockable Item

For details on technical parameters & non stockable items contact nearest sales office.



Other Ratings on request

(IS: 13340 / IEC: 60831)

## Champ - Heavy Duty Plus Square Capacitors

- High inrush current withstand capability.
- Output range 1 kVAr to 100 kVAr.
- Soft sticky resin to withstand high temperature and current stress.
- Penta safety protection.
- Explosion proof, low losses & high over current withstand capabilities.



HSN Code: 85321000

Rating kVAr	Item Code	Description	Standard Pack No of unit/s	Master Pack No of unit/s	Per Unit LP (₹)
<b>Rated Voltage 440 V AC, 3%, 50 Hz, Delta Connection</b>					
1 kVAr	QHBTMC5001X0	Champ 440 V 50 Hz-1 kVAr 3 PH	1 N	30 N	563.00
2 kVAr	QHBTMC5002X0	Champ 440 V 50 Hz-2 kVAr 3 PH	1 N	30 N	927.00
3 kVAr ▲	QHBTMC5003X0	Champ 440 V 50 Hz-3 kVAr 3 PH	1 N	24 N	1389.00
4 kVAr	QHBTMC5004X0	Champ 440 V 50 Hz-4 kVAr 3 PH	1 N	24 N	1852.00
5 kVAr ▲	QHBTMC5005X0	Champ 440 V 50 Hz-5 kVAr 3 PH	1 N	1 N	2242.00
6 kVAr	QHBTMC5006X0	Champ 440 V 50 Hz-6 kVAr 3 PH	1 N	1 N	2684.00
7.5 kVAr ▲	QHBTMC5007X5	Champ 440 V 50 Hz-7.5 kVAr 3 PH	1 N	1 N	3354.00
8 kVAr	QHBTMC5008X0	Champ 440 V 50 Hz-8 kVAr 3 PH	1 N	1 N	3578.00
10 kVAr ▲	QHBTMC5010X0	Champ 440 V 50 Hz-10 kVAr 3 PH	1 N	1 N	4467.00
12.5 kVAr ▲	QHBTMC5012X5	Champ 440 V 50 Hz-12.5 kVAr 3 PH	1 N	1 N	5585.00
15 kVAr ▲	QHBTMC5015X0	Champ 440 V 50 Hz-15 kVAr 3 PH	1 N	1 N	6708.00
20 kVAr ▲	QHBTMC5020X0	Champ 440 V 50 Hz-20 kVAr 3 PH	1 N	1 N	8939.00
25 kVAr ▲	QHBTMC5025X0	Champ 440 V 50 Hz-25 kVAr 3PH	1 N	1 N	11175.00
30 kVAr	QHBTMC5030X0	Champ 440 V 50 Hz-30 kVAr 3 PH	1 N	1 N	13406.00
50 kVAr	QHBTMC5050X0	Champ 440 V 50 Hz-50 kVAr 3 PH	1 N	1 N	23499.00
<b>Rated Voltage 480 V AC, 3%, 50 Hz, Delta Connection</b>					
5 kVAr	QHBTMD5005X0	Champ 480 V 50 Hz-5 kVAr 3 PH	1 N	1 N	2403.00
6 kVAr	QHBTMD5006X0	Champ 480 V 50 Hz-6 kVAr 3 PH	1 N	1 N	2886.00
7.5 kVAr	QHBTMD5007X5	Champ 480 V 50 Hz-7.5 kVAr 3 PH	1 N	1 N	3609.00
10 kVAr	QHBTMD5010X0	Champ 480 V 50 Hz-10 kVAr 3 PH	1 N	1 N	4810.00
12.5 kVAr	QHBTMD5012X5	Champ 480 V 50 Hz-12.5 kVAr 3 PH	1 N	1 N	6012.00
15 kVAr	QHBTMD5015X0	Champ 480 V 50 Hz-15 kVAr 3 PH	1 N	1 N	7213.00
20 kVAr	QHBTMD5020X0	Champ 480 V 50 Hz-20 kVAr 3 PH	1 N	1 N	9615.00
25 kVAr	QHBTMD5025X0	Champ 480 V 50 Hz-25 kVAr 3 PH	1 N	1 N	12018.00
30 kVAr	QHBTMD5030X0	Champ 480 V 50 Hz-30 kVAr 3 PH	1 N	1 N	14425.00
50 kVAr	QHBTMD5050X0	Champ 480 V 50 Hz-50 kVAr 3 PH	1 N	1 N	24040.00
<b>Rated Voltage 525 V AC, 3%, 50 Hz, Delta Connection</b>					
5 kVAr	QHBTMF5005X0	Champ 525 V 50 Hz-5 kVAr 3 PH	1 N	1 N	2403.00
6 kVAr	QHBTMF5006X0	Champ 525 V 50 Hz-6 kVAr 3 PH	1 N	1 N	2886.00
7.5 kVAr	QHBTMF5007X5	Champ 525 V 50 Hz-7.5 kVAr 3 PH	1 N	1 N	3609.00
10 kVAr	QHBTMF5010X0	Champ 525 V 50 Hz-10 kVAr 3 PH	1 N	1 N	4810.00
12.5 kVAr	QHBTMF5012X5	Champ 525 V 50 Hz-12.5 kVAr 3 PH	1 N	1 N	6012.00
15 kVAr	QHBTMF5015X0	Champ 525 V 50 Hz-15 kVAr 3 PH	1 N	1 N	7213.00
20 kVAr	QHBTMF5020X0	Champ 525 V 50 Hz-20 kVAr 3 PH	1 N	1 N	9615.00
25 kVAr	QHBTMF5025X0	Champ 525 V 50 Hz-25 kVAr 3 PH	1 N	1 N	12018.00
30 kVAr	QHBTMF5030X0	Champ 525 V 50 Hz-30 kVAr 3 PH	1 N	1 N	14425.00
50 kVAr	QHBTMF5050X0	Champ 525 V 50 Hz-50 kVAr 3 PH	1 N	1 N	24799.00

\*\*Higher Rating above 50 kVAr available on request.

▲ Stockable Item

For details on technical parameters & non stockable items contact nearest sales office.

(IS: 13340 / IEC: 60831)

Effective from 1st April, 2026

List Price (LP) are in Indian ₹ & as per Standard Terms & Conditions **HAVELLS 87**

# Champion - SHD Square Capacitors

- High inrush current withstand capability.
- Output range 1 kVAr to 100 kVAr.
- Soft sticky resin to withstand high temperature and current stress.
- Penta safety protection.
- Explosion proof, low losses & high over current withstand capabilities.



HSN Code: 85321000

Rating kVAr	Item Code	Description	Standard Pack No of unit/s	Master Pack No of unit/s	Per Unit LP (₹)
<b>Rated Voltage 440 V AC, 3<math>\phi</math>, 50 Hz, Delta Connection</b>					
1 kVAr	QHSTMC5001X0	Champion 440 V 50 Hz-1 kVAr 3 PH	1 N	16 N	1290.00
2 kVAr	QHSTMC5002X0	Champion 440 V 50 Hz-2 kVAr 3 PH	1 N	1 N	2569.00
3 kVAr	QHSTMC5003X0	Champion 440 V 50 Hz-3 kVAr 3 PH	1 N	1 N	3859.00
4 kVAr	QHSTMC5004X0	Champion 440 V 50 Hz-4 kVAr 3 PH	1 N	1 N	4472.00
5 kVAr	QHSTMC5005X0	Champion 440 V 50 Hz-5 kVAr 3 PH	1 N	1 N	4514.00
6 kVAr	QHSTMC5006X0	Champion 440 V 50 Hz-6 kVAr 3 PH	1 N	1 N	5107.00
7.5 kVAr	QHSTMC5007X5	Champion 440 V 50 Hz-7.5 kVAr 3 PH	1 N	1 N	6381.00
8 kVAr	QHSTMC5008X0	Champion 440 V 50 Hz-8 kVAr 3 PH	1 N	1 N	6807.00
10 kVAr	QHSTMC5010X0	Champion 440 V 50 Hz-10 kVAr 3 PH	1 N	1 N	8508.00
12.5 kVAr	QHSTMC5012X5	Champion 440 V 50 Hz-12.5 kVAr 3 PH	1 N	1 N	10634.00
15 kVAr	QHSTMC5015X0	Champion 440 V 50 Hz-15 kVAr 3 PH	1 N	1 N	12751.00
20 kVAr	QHSTMC5020X0	Champion 440 V 50 Hz-20 kVAr 3 PH	1 N	1 N	17004.00
25 kVAr	QHSTMC5025X0	Champion 440 V 50 Hz-25 kVAr 3 PH	1 N	1 N	21258.00
30 kVAr	QHSTMC5030X0	Champion 440 V 50 Hz-30 kVAr 3 PH	1 N	1 N	26640.00
50 kVAr	QHSTMC5050X0	Champion 440 V 50 Hz-50 kVAr 3 PH	1 N	1 N	44403.00
<b>Rated Voltage 480 V AC, 3<math>\phi</math>, 50 Hz, Delta Connection</b>					
5 kVAr	QHSTMD5005X0	Champion 480 V 50 Hz-5 kVAr 3 PH	1 N	1 N	4561.00
6 kVAr	QHSTMD5006X0	Champion 480 V 50 Hz-6 kVAr 3 PH	1 N	1 N	5159.00
7.5 kVAr	QHSTMD5007X5	Champion 480 V 50 Hz-7.5 kVAr 3 PH	1 N	1 N	6443.00
10 kVAr	QHSTMD5010X0	Champion 480 V 50 Hz-10 kVAr 3 PH	1 N	1 N	8591.00
12.5 kVAr	QHSTMD5012X5	Champion 480 V 50 Hz-12.5 kVAr 3 PH	1 N	1 N	10738.00
15 kVAr	QHSTMD5015X0	Champion 480 V 50 Hz-15 kVAr 3 PH	1 N	1 N	12886.00
20 kVAr	QHSTMD5020X0	Champion 480 V 50 Hz-20 kVAr 3 PH	1 N	1 N	17176.00
25 kVAr	QHSTMD5025X0	Champion 480 V 50 Hz-25 kVAr 3 PH	1 N	1 N	21471.00
30 kVAr	QHSTMD5030X0	Champion 480 V 50 Hz-30 kVAr 3 PH	1 N	1 N	26910.00
50 kVAr	QHSTMD5050X0	Champion 480 V 50 Hz-50 kVAr 3 PH	1 N	1 N	44845.00
<b>Rated Voltage 525 V AC, 3<math>\phi</math>, 50 Hz, Delta Connection</b>					
5 kVAr	QHSTMF5005X0	Champion 525 V 50 Hz-5 kVAr 3 PH	1 N	1 N	4608.00
6 kVAr	QHSTMF5006X0	Champion 525 V 50 Hz-6 kVAr 3 PH	1 N	1 N	5206.00
7.5 kVAr	QHSTMF5007X5	Champion 525 V 50 Hz-7.5 kVAr 3 PH	1 N	1 N	6506.00
10 kVAr	QHSTMF5010X0	Champion 525 V 50 Hz-10 kVAr 3 PH	1 N	1 N	8679.00
12.5 kVAr	QHSTMF5012X5	Champion 525 V 50 Hz-12.5 kVAr 3 PH	1 N	1 N	10848.00
15 kVAr	QHSTMF5015X0	Champion 525 V 50 Hz-15 kVAr 3 PH	1 N	1 N	13016.00
20 kVAr	QHSTMF5020X0	Champion 525 V 50 Hz-20 kVAr 3 PH	1 N	1 N	17353.00
25 kVAr	QHSTMF5025X0	Champion 525 V 50 Hz-25 kVAr 3 PH	1 N	1 N	21684.00
30 kVAr	QHSTMF5030X0	Champion 525 V 50 Hz-30 kVAr 3 PH	1 N	1 N	27181.00
50 kVAr	QHSTMF5050X0	Champion 525 V 50 Hz-50 kVAr 3 PH	1 N	1 N	45303.00

\*\*Higher Rating above 50 kVAr available on request.

▲ Stockable Item

For details on technical parameters & non stockable items contact nearest sales office.

(IS: 13340)

# Harmonic Detuned Reactor

## Range:

- 1 kVAr to 100 kVAr
- Available in: Copper & Aluminium
- Detuning Factor: 7% and 14% corresponding to tuning Frequencies of 190 Hz and 135 Hz for the base of 50 Hz
- Rated Operational Voltage: 380 V to 690 V
- linearity : 185% to 225% of In

## Features:

- High linearity 185% to 225%
- Insulation Class H
- Temperature protection - NC contact (UL Approved)
- Long expected life time
- Low noise & very low losses
- Compliance to IEC 61558



## Selection Chart: Capacitor voltage and kVAr selection for 7% and 14% reactors

Effective kVAr output	With 7% detuned reactor		With 14% detuned reactor	
	Reactor (440 V)	Capacitor (480 V)**	Reactor (440 V)	Capacitor (525 V)**
5 kVAr	5 kVAr	6 kVAr / 480 V	5 kVAr	6 kVAr / 525 V
10 kVAr	10 kVAr	12.5 kVAr / 480 V	10 kVAr	12.5 kVAr / 525 V
12.5 kVAr	12.5 kVAr	15 kVAr / 480 V	12.5 kVAr	15 kVAr / 525 V
15 kVAr	15 kVAr	20 kVAr / 480 V	15 kVAr	20 kVAr / 525 V
20 kVAr	20 kVAr	25 kVAr / 480 V	20 kVAr	25 kVAr / 525 V
25 kVAr	25 kVAr	30 kVAr / 480 V	25 kVAr	30 kVAr / 525 V
50 kVAr	50 kVAr	60 kVAr / 480 V	50 kVAr	60 kVAr / 525 V
75 kVAr	75 kVAr	90 kVAr / 480 V	75 kVAr	90 kVAr / 525 V
100 kVAr	100 kVAr	120 kVAr / 480 V	100 kVAr	120 kVAr / 525 V



## Harmonic Detuned Reactor Aluminium

HSN Code: 85049090

Rating kVAr	Cat. Code	Description	Per Unit LP (₹)
<b>Rated Voltage 440 V AC, F = 50 Hz, P = 7% ( Fr = 189 Hz) / Linearity: L &gt; 0.95 Lr for current up to 1.85 . I1 (Aluminium)</b>			
1 kVAr	QHHTLCV001X0	H. D.- REACTOR, 7% AL, 01 kVAr 440 V AC	6625.00
2 kVAr	QHHTLCV002X0	H. D.- REACTOR, 7% AL, 02 kVAr 440 V AC	7223.00
3 kVAr	QHHTLCV003X0	H. D.- REACTOR, 7% AL, 03 kVAr 440 V AC	8180.00
4 kVAr	QHHTLCV004X0	H. D.- REACTOR, 7% AL, 04 kVAr 440 V AC	8700.00
5 kVAr	QHHTLCV005X0	H. D.- REACTOR, 7% AL, 05 kVAr 440 V AC	10723.00
10 kVAr	QHHTLCV010X0	H. D.- REACTOR, 7% AL, 10 kVAr 440 V AC	13042.00
12.5 kVAr	QHHTLCV012X5	H. D.- REACTOR, 7% AL, 12.5 kVAr 440 V AC	13333.00
15 kVAr	QHHTLCV015X0	H. D.- REACTOR, 7% AL, 15 kVAr 440 V AC	18986.00
20 kVAr	QHHTLCV020X0	H. D.- REACTOR, 7% AL, 20 kVAr 440 V AC	20868.00
25 kVAr	QHHTLCV025X0	H. D.- REACTOR, 7% AL, 25 kVAr 440 V AC	21591.00
50 kVAr	QHHTLCV050X0	H. D.- REACTOR, 7% AL, 50 kVAr 440 V AC	34471.00
75 kVAr	QHHTLCV075X0	H. D.- REACTOR, 7% AL, 75 kVAr 440 V AC	57091.00
100 kVAr	QHHTLCV100X0	H. D.- REACTOR, 7% AL, 100 kVAr 440 V AC	65203.00
<b>Rated Voltage 440 V AC, F = 50 Hz, P = 14% ( Fr = 189 Hz) / Linearity: L &gt; 0.95 Lr for current up to 1.85 . I1 (Aluminium)</b>			
5 kVAr	QHHTLCW005X0	H. D.- REACTOR, 14% AL, 05 kVAr 440 V AC	Price on Request
10 kVAr	QHHTLCW010X0	H. D.- REACTOR, 14% AL, 10 kVAr 440 V AC	
12.5 kVAr	QHHTLCW012X5	H. D.- REACTOR, 14% AL, 12.5 kVAr 440 V AC	
15 kVAr	QHHTLCW015X0	H. D.- REACTOR, 14% AL, 15 kVAr 440 V AC	
20 kVAr	QHHTLCW020X0	H. D.- REACTOR, 14% AL, 20 kVAr 440 V AC	
25 kVAr	QHHTLCW025X0	H. D.- REACTOR, 14% AL, 25 kVAr 440 V AC	
50 kVAr	QHHTLCW050X0	H. D.- REACTOR, 14% AL, 50 kVAr 440 V AC	
75 kVAr	QHHTLCW075X0	H. D.- REACTOR, 14% AL, 75 kVAr 440 V AC	
100 kVAr	QHHTLCW100X0	H. D.- REACTOR, 14% AL, 100 kVAr 440 V AC	

## Harmonic Detuned Reactor Copper

HSN Code: 85049090

Rating kVAr	Cat. Code	Description	Per Unit LP (₹)
<b>Rated Voltage 440 V AC, F = 50 Hz, P = 7% ( Fr = 133 Hz) / Linearity: L &gt; 0.95 Lr for current up to 1.85 . I1, (Copper)</b>			
1 kVAr	QHHTLCV001X0	H. D.- REACTOR, 7% CU, 01 kVAr 440 V AC	9995.00
2 kVAr	QHHTLCV002X0	H. D.- REACTOR, 7% CU, 02 kVAr 440 V AC	10915.00
3 kVAr	QHHTLCV003X0	H. D.- REACTOR, 7% CU, 03 kVAr 440 V AC	12371.00
4 kVAr	QHHTLCV004X0	H. D.- REACTOR, 7% CU, 04 kVAr 440 V AC	13151.00
5 kVAr	QHHTLCV005X0	H. D.- REACTOR, 7% CU, 05 kVAr 440 V AC	15325.00
10 kVAr	QHHTLCV010X0	H. D.- REACTOR, 7% CU, 10 kVAr 440 V AC	21419.00
12.5 kVAr	QHHTLCV012X5	H. D.- REACTOR, 7% CU, 12.5 kVAr 440 V AC	22038.00
15 kVAr	QHHTLCV015X0	H. D.- REACTOR, 7% CU, 15 kVAr 440 V AC	31580.00
20 kVAr	QHHTLCV020X0	H. D.- REACTOR, 7% CU, 20 kVAr 440 V AC	32688.00
25 kVAr	QHHTLCV025X0	H. D.- REACTOR, 7% CU, 25 kVAr 440 V AC	33301.00
50 kVAr	QHHTLCV050X0	H. D.- REACTOR, 7% CU, 50 kVAr 440 V AC	50232.00
75 kVAr	QHHTLCV075X0	H. D.- REACTOR, 7% CU, 75 kVAr 440 V AC	82847.00
100 kVAr	QHHTLCV100X0	H. D.- REACTOR, 7% CU, 100 kVAr 440 V AC	106476.00
<b>Rated Voltage 440 V AC, F = 50 Hz, P = 14% ( Fr = 189 Hz) / Linearity: L &gt; 0.95 Lr for current up to 1.85 . I1 (Copper)</b>			
5 kVAr	QHHTLCW005X0	H. D.- REACTOR, 14% CU, 05 kVAr 440 V AC	Price on Request
10 kVAr	QHHTLCW010X0	H. D.- REACTOR, 14% CU, 10 kVAr 440 V AC	
12.5 kVAr	QHHTLCW012X5	H. D.- REACTOR, 14% CU, 12.5 kVAr 440 V AC	
15 kVAr	QHHTLCW015X0	H. D.- REACTOR, 14% CU, 15 kVAr 440 V AC	
20 kVAr	QHHTLCW020X0	H. D.- REACTOR, 14% CU, 20 kVAr 440 V AC	
25 kVAr	QHHTLCW025X0	H. D.- REACTOR, 14% CU, 25 kVAr 440 V AC	
50 kVAr	QHHTLCW050X0	H. D.- REACTOR, 14% CU, 50 kVAr 440 V AC	
75 kVAr	QHHTLCW075X0	H. D.- REACTOR, 14% CU, 75 kVAr 440 V AC	
100 kVAr	QHHTLCW100X0	H. D.- REACTOR, 14% CU, 100 kVAr 440 V AC	

▲ Stockable Item

For details on technical parameters & non stockable items contact nearest sales office.

**90 HAVELLS** Effective from 1st April, 2026

List Price (LP) are in Indian ₹ & as per Standard Terms & Conditions

# Intelligent Power Factor Controller

IEC: 61010-1

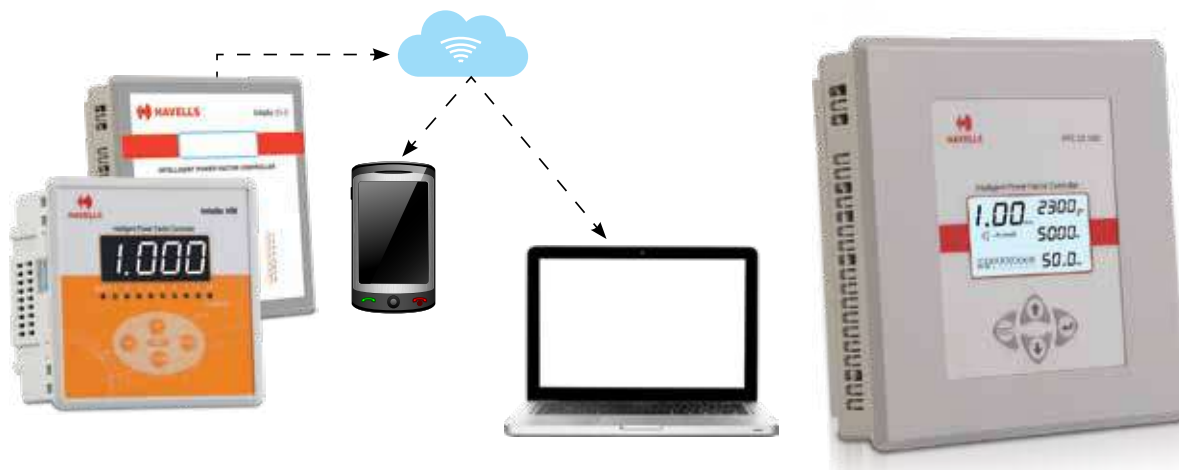

Range:

- 08 and 12 Steps
- 1CT & 3 CT version
- 7 segment LED display
- Size: 96 mm x 96 mm & 144 mm x 144 mm

Features:

- LCD Type with dual colour backlight
- Auxiliary supply 90 V AC - 550 V AC
- Dual Password Protection
- Automatic CT Polarity detection
- NTC Temperature Sensor
- Communication Interface RS 485 & ModBus RTU (Only for 12 Relay option)
- Power Factor Measurement Range: 0.8 lag to 0.8 lead
- Advance Micro-Controller based logic
- Data logging facility (optional)

HSN Code: 85364900

Steps	Item Code	Description	Standard Pack No of unit/s	Master Pack No of unit/s	Per Unit LP (₹)
Intelligent Power Factor Controller (IPFC CS- 1001) 1 CT					
8 ▲	QHOSBS5D0008	IPFC CS 96 x 96	1 N	5 N	7738.00
8 ▲	QHOSBS5N0008	IPFC CS 144 x 144	1 N	5 N	12782.00
12 ▲	QHOSBS5N0012	IPFC CS 1001-112-90 V / 550 V AC 144 x 144	1 N	5 N	14836.00
Intelligent Power Factor Controller (IPFC CS- 1003) 3 CT					
8 ▲	QHOTBS5H0008	IPFC CS 1001-112-90 V / 550 V AC 144 x 144	1 N	5 N	20488.00
12 ▲	QHOTBS5H0012	IPFC CS 1003-312-90 V / 550 V AC 144 x 144	1 N	5 N	25558.00

## Capacitor Switching Solutions

### Thyristor Switch

- Fast Switching Speed
- High power handling capacity
- Low losses
- Reliability and longevity
- Real time power factor correction



HSN Code: 85371000

Cat. Code	Description	Per Unit LP (₹)
QHZCF00111	Thyristor Switch 15 kVAr	34648.00
QHZCF00121	Thyristor Switch 25 kVAr	39531.00
QHZCF00131	Thyristor Switch 50 kVAr	47534.00
QHZCF00141	Thyristor Switch 100 kVAr	71526.00

Other Ratings on request

▲ Stockable Item

For details on technical parameters & non stockable items contact nearest sales office.

Effective from 1st April, 2026

List Price (LP) are in Indian ₹ & as per Standard Terms & Conditions **HAVELLS 91**

# Magnetic Contactor

## Capacitor Duty Contactor



### Features:

- Range : 3 kVAr to 66 kVAr
- De-latching Type design of Resistor Switching Block
- Low VA Burden Wide operating band coils with Class H Insulation
- Common accessories with HGS Range
- High Operating Frequency - 240 Operations per hour
- Handle high inrush current capability
- Utilization category AC-6b
- Finger proof IP20 terminals



HSN Code: 85369090

Frame Size	kVAr Rating AC-6b	Inst. Aux. Contact		Item Code	Per Unit LP (₹)
	415 V / 440 V	NO	NC		
1	3 kVAr ▲	1	0	IHPHE003110*	3678.00
	3 kVAr	0	1	IHPHE003101*	3678.00
	5 kVAr ▲	1	0	IHPHE005110*	3856.00
	5 kVAr	0	1	IHPHE005101*	3856.00
	10 kVAr ▲	1	0	IHPHE010110*	4666.00
	10 kVAr	0	1	IHPHE010101*	4666.00
	12.5 kVAr	1	0	IHPHE12X110*	5276.00
	12.5 kVAr	0	1	IHPHE12X101*	5168.00
	15 kVAr ▲	1	0	IHPHE015110*	6464.00
	15 kVAr	0	1	IHPHE015101*	6464.00
2	20 kVAr ▲	1	0	IHPHE020210*	7107.00
	20 kVAr	0	1	IHPHE020201*	7107.00
	25 kVAr ▲	1	0	IHPHE025210*	8095.00
	25 kVAr	0	1	IHPHE025201*	8095.00
	33.3 kVAr	1	0	IHPHE33X210*	11740.00
	33.3 kVAr	0	1	IHPHE33X201*	11740.00
3	33.3 kVAr	1	1	IHPHE33X311*	14148.00
	40 kVAr	2	2	IHPHE040322*	21741.00
4	50 kVAr ▲	2	2	IHPHE050422*	22626.00
	66 kVAr	2	2	IHPHE066422*	26536.00

\*To complete the Item Code suffix the coil voltage from the coil voltage table  
33.3 kVAr contactor in Frame-3 can be used where higher terminal capacity is required.

## Coil Voltage Selection Table

3 kVAr - 66 kVAr AC Coil

Product	110 V AC	240 V AC	415 V AC	150 V AC - 300 V AC	260 V AC - 440 V AC
HGS Capacitor Duty Contactor (3 kVAr - 66 kVAr)	H	N ▲	T	S ▲	W

▲ Stockable Item  
For details on technical parameters & non stockable items contact nearest sales office.



**Why pay more  
due to low Power Factor**

**INSTALL APFC PANEL  
& SAVE MONEY  
BY REDUCING kVAh**

*Is still there a difference in kVAh and kWh in your  
Electricity Bill due to low Power Factor ?*

0	334240 kVAh
20	318980 kWh
	1404 kVA

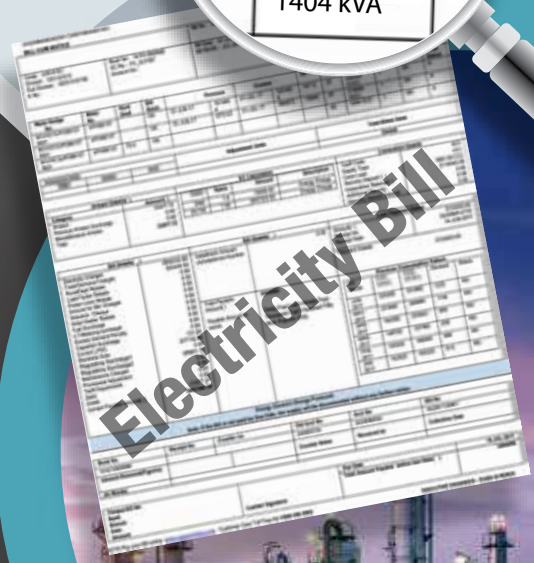

**Features**

- Ergonomic, compact and robust design
- Designed with 100% copper conductor
- Advance C-MOS technology based micro processor for intelligent power factor control

Automatic temp. control through fans and louvers in panel



## Smarty - Automatic Power Factor Correction Panel

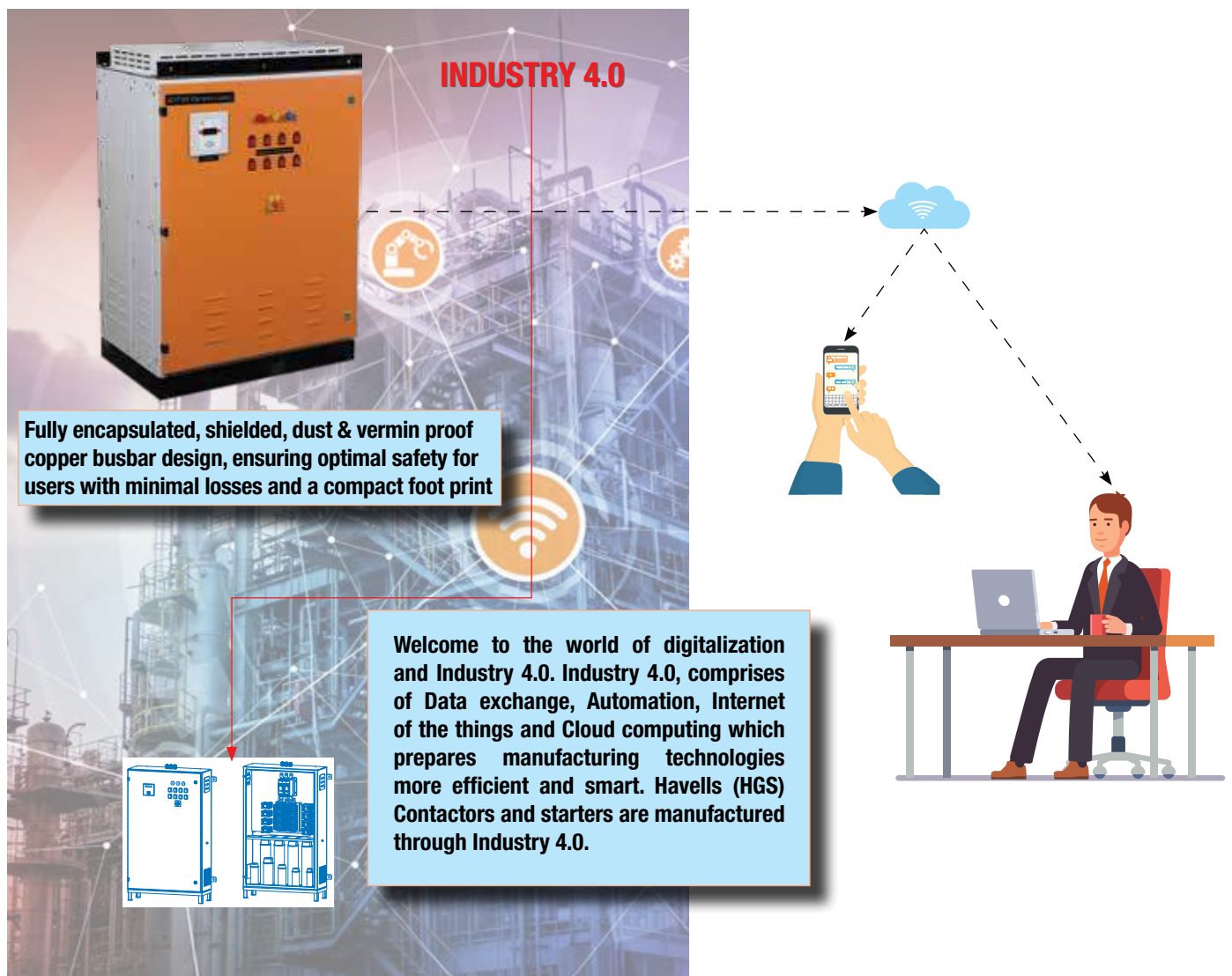

**INDUSTRY 4.0**

Fully encapsulated, shielded, dust & vermin proof copper busbar design, ensuring optimal safety for users with minimal losses and a compact foot print

Welcome to the world of digitalization and Industry 4.0. Industry 4.0, comprises of Data exchange, Automation, Internet of the things and Cloud computing which prepares manufacturing technologies more efficient and smart. Havells (HGS) Contactors and starters are manufactured through Industry 4.0.

### Range

- ▶ Output Rating: 10 kVAr - 350 kVAr as a standard SKU
- ▶ Other ratings 350 kVAr above on request
- ▶ Switching: Contactor / Thyristorised (Ultra Fast)
- ▶ APFC with Thyristor available on request

### Features

- ▶ Ergonomic, compact and robust design
- ▶ Designed with Fully copper conductor
- ▶ Super Heavy Duty Capacitor for long life
- ▶ Advance C-MOS technology based micro processor relay for intelligent power factor control
- ▶ Air core reactor for extra safety from inrush current (High currents)
- ▶ Automatic temp. control through fans and louvers in panel

### Construction

- ▶ Manufactured with highly precise modern Amada CNC machine
- ▶ 11 tank process for corrosion proof powder coating
- ▶ Provision of top and bottom cable entry
- ▶ Double side earthing connection
- ▶ IP 30 & above as per customer demand
- ▶ Ref. Standard: IS 16636 / IEC 61439

### Principle Operation

- ▶ To continuously sense and monitor the load conditions by the use of the external CT (whose output is fed to the control relay).
- ▶ To automatically switch ON and switch OFF relevant capacitor steps to ensure consistent power factor.
- ▶ To ensure easy user interface for enabling reliable understanding of system operation, such as display of real time power factor, number of switching operations carried out etc.
- ▶ To protect against any electrical faults in a manner that will ensure safe isolation of the power factor correction equipment.

# Smarty - Automatic Power Factor Correction Panel

IEC: 61921 / IS: 16636

## APFC Panel without Reactor

HSN Code: 85371000

Rating kVAr	Cat. Code	Description	Main Incomer	Per Unit LP (₹)
Rated Voltage 415 V AC, 3 $\phi$ , 50 Hz, Delta Connection, Super Heavy Duty Cylindrical Capacitor				
15 kVAr	QHXTCB5015X0	15 kVAr / 415 V APFC Panel CYCAP	MCB 40 A / 10 kA	84360.00
20 kVAr	QHXTCB5020X0	20 kVAr / 415 V APFC Panel CYCAP	MCB 40 A / 10 kA	91104.00
25 kVAr	QHXTCB5025X0	25 kVAr / 415 V APFC Panel CYCAP	MCB 63 A / 10 kA	101790.00
30 kVAr	QHXTCB5030X0	30 kVAr / 415 V APFC Panel CYCAP	MCB 63 A / 10 kA	121472.00
40 kVAr	QHXTCB5040X0	40 kVAr / 415 V APFC Panel CYCAP	MCCB 100 A / 25 kA	165553.00
50 kVAr	QHXTCB5050X0	50 kVAr / 415 V APFC Panel CYCAP	MCCB 100 A / 25 kA	186488.00
75 kVAr	QHXTCB5075X0	75 kVAr / 415 V APFC Panel CYCAP	MCCB 160 A / 25 kA	275569.00
80 kVAr	QHXTCB5080X0	80 kVAr / 415 V APFC Panel CYCAP	MCCB 160 A / 25 kA	293000.00
100 kVAr	QHXTCB5100X0	100 kVAr / 415 V APFC Panel CYCAP	MCCB 160 A / 25 kA	321121.00
125 kVAr	QHXTCB5125X0	125 kVAr / 415 V APFC Panel CYCAP	MCCB 250 A / 25 kA	444283.00
150 kVAr	QHXTCB5150X0	150 kVAr / 415 V APFC Panel CYCAP	MCCB 320 A / 35 kA	505581.00
175 kVAr	QHXTCB5175X0	175 kVAr / 415 V APFC Panel CYCAP	MCCB 320 A / 35 kA	559006.00
200 kVAr	QHXTCB5200X0	200 kVAr / 415 V APFC Panel CYCAP	MCCB 400 A / 35 kA	640776.00
250 kVAr	QHXTCB5250X0	250 kVAr / 415 V APFC Panel CYCAP	MCCB 500 A / 35 kA	793744.00
300 kVAr	QHXTCB5300X0	300 kVAr / 415 V APFC Panel CYCAP	MCCB 630 A / 50 kA	916682.00
350 kVAr	QHXTCB5350X0	350 kVAr / 415 V APFC Panel CYCAP	MCCB 630 A / 50 kA	1031966.00

\* for Higher rating please contact our branch office

## APFC Technical Details

Rating kVAr	Stages	Dimensions HeightXWidthXDepth (mm)
Rated Voltage 415 V AC, 3 $\phi$ , 50 Hz, Delta Connection, Super Heavy Duty Cylindrical Capacitor		
15 kVAr	2 (4 kVAr) + 3 (2 kVAr) + 1 (1 kVAr)	(650x600x200) mm
20 kVAr	2 (5 kVAr) + 2 (3 kVAr) + 2 (2 kVAr)	(650x600x200) mm
25 kVAr	4 (5 kVAr) + 1 (3 kVAr) + 1 (2 kVAr)	(650x600x200) mm
30 kVAr	1 (10 kVAr) + 3 (5 kVAr) + 1 (3 kVAr) + 1 (2 kVAr)	(900x600x200) mm
40 kVAr	2 (12.5 kVAr) + 2 (5 kVAr) + 1 (3 kVAr) + 1 (2 kVAr)	(900x600x200) mm
50 kVAr	3 (12.5 kVAr) + 1 (7.5 kVAr) + 1 (3 kVAr) + 1 (2 kVAr)	(900x600x200) mm
75 kVAr	2 (20 kVAr) + 2 (10 kVAr) + 2 (5 kVAr) + 1 (3 kVAr) + 1 (2 kVAr)	(1100x700x250) mm
80 kVAr	2 (20 kVAr) + 2 (12.5 kVAr) + 2 (5 kVAr) + 1 (3 kVAr) + 1 (2 kVAr)	(1100x700x250) mm
100 kVAr	4 (20 kVAr) + 1 (10 kVAr) + 1 (5 kVAr) + 1 (3 kVAr) + 1 (2 kVAr)	(1100x700x250) mm
125 kVAr	1 (50 kVAr) + 2 (25 kVAr) + 1 (10 kVAr) + 2 (5 kVAr) + 1 (3 kVAr) + 1 (2 kVAr)	(1175x800x540) mm
150 kVAr	2 (50 kVAr) + 1 (25 kVAr) + 1 (10 kVAr) + 2 (5 kVAr) + 1 (3 kVAr) + 1 (2 kVAr)	(1175x800x540) mm
175 kVAr	2 (50 kVAr) + 2 (25 kVAr) + 1 (10 kVAr) + 3 (5 kVAr)	(1175x800x540) mm
200 kVAr	3 (50 kVAr) + 1 (25 kVAr) + 1 (10 kVAr) + 3 (5 kVAr)	(1175x800x540) mm
250 kVAr	4 (50 kVAr) + 1 (25 kVAr) + 2 (10 kVAr) + 1 (5 kVAr)	(1175x800x540) mm
300 kVAr	1 (100 kVAr) + 3 (50 kVAr) + 1 (25 kVAr) + 2 (10 kVAr) + 1 (5 kVAr)	(1675x1200x700) mm
350 kVAr	2 (100 kVAr) + 2 (50 kVAr) + 1 (25 kVAr) + 2 (10 kVAr) + 1 (5 kVAr)	(1675x1200x700) mm

## APFC Panel with Detuned Reactor / Thyristor Switching

Rating kVAr	Cat. Code	Description	Per Unit LP (₹)
10 kVAr - 1000 kVAr		10 kVAr -1000 kVAr APFC Panel	Price on Request

▲ Stockable Item

For details on technical parameters & non stockable items contact nearest sales office.

Effective from 1st April, 2026

List Price (LP) are in Indian ₹ & as per Standard Terms & Conditions **HAVELLS 95**

# Active Harmonic Filters & SVG Panels Stack Design



## IEEE 519-2014 Guidelines for Harmonics Limits

Table 2 - Current distortion limits for systems rated 120 V through 69 kV

Maximum harmonic current distortion in percent of $I_L$						
Individual harmonic order (odd harmonics) <sup>a, b</sup>						
$I_h/I_L$	$3 \leq h < 11$	$11 \leq h < 17$	$17 \leq h < 23$	$23 \leq h < 35$	$35 \leq h \leq 50$	TDD
<20	4.0	2.0	1.5	0.6	0.3	5.0
20<50	7.0	3.5	2.5	1.0	0.5	8.0
50<100	10.0	4.5	4.0	1.5	0.7	12.0
100<1000	12.0	5.5	5.0	2.0	1.0	15.0
>1000	15.0	7.0	6.0	2.5	1.4	20.0

## AHF Technical



System Connection	3 P / 3 W or 3 P / 4 W
Design	Stack / Modular Design
Input Voltage	415 V (+/-10%) and 50 Hz (+/-)5% other rating on request
Phase compensation current range	15 A - 1000 A (other ratings on request)
Technology	Two Level Topology / Three Level Topology
Harmonic filtration range	2nd to 51st order
Individual harmonic selection	Available
Power factor compensation	100% (Lead / Lag)
Load Balancing	Negative Sequence Compensation (Zero Sequence compensation in 3 P / 4 W range)
Neutral Current Compensation	Available
Reaction time	<0.3 ms
Interface (Communication)	GSM, MODBUS RTU, USB, Ethernet, Profibus Compatible
IP Protection Class	IP-30 and higher on request
System Cooling	Forced air colling
Overheating Protection	Yes
Relative Humidity	96% (Non condensing)
Ambient Temperature	No deration upto 50 °C

Rating	Cat. Code	Description	Per Unit LP (₹)
50 A - 1000 A		50 A -1000 A AHF Panel	Price on Request
50 kVAr - 1000 kVAr		50 kVAr -1000 kVAr SVG Panel	



## Active Harmonic Filters / SVG Modules

### Features

- Compact Design
- 3Phase 3 wire, 3Phase 4 wire
- Complete Harmonics Mitigation
- Compliance of IEEE 519
- Load Balancing
- Step Less Power Factor Correction
- Neutral Compensation
- Reduction of power losses
- IGBT based Ultra fast compensation



Rating in (A)	Cat No.	Description	Per Unit MRP (₹)
30 A	On Request	30 A / 415 AHF Module	On Request
50 A		50 A / 415 AHF Module	
75 A		75 A / 415 AHF Module	
100 A		100 A / 415 AHF Module	
125 A		125 A / 415 AHF Module	
150 A		150 A / 415 AHF Module	



Rating in (kVAr)	Cat No.	Description	Per Unit MRP (₹)
30 kVAr	On Request	30 A / 415 SVG Module	On Request
50 kVAr		50 A / 415 SVG Module	
75 kVAr		75 A / 415 SVG Module	
100 kVAr		100 A / 415 SVG Module	
125 kVAr		125 A / 415 SVG Module	
150 kVAr		150 A / 415 SVG Module	



Reduction of power losses

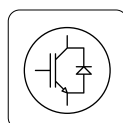

IGBT Based Technology

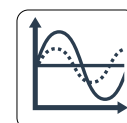

Harmonic Corrections

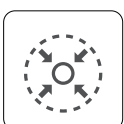

Compliance of IEEE 519

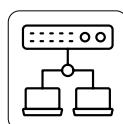

Load Balancing

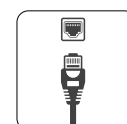

Communication with RS-485 Port

# Consulting, Optimizing & Delivering Performance

## Power Quality Audit Scope

- Capturing load profile of all relevant sections (with non linear loads) starting with the PCC.
- Checking effectiveness of installed Reactive power compensation system
- Identify zones of failures harmonic.
- Study electricity bills and identify scope of optimization in energy consumption pattern.

## Final Deliverables

- A summary of various electrical parameters & recorded trends.
- Analysis of above data mentioning Key high lights
- Recommended Solution address the various power quality issues identified
- Estimate Potential Saving - Estimate the direct savings and provide ROI calculation (wherever applicable).



# Agriculture Duty Capacitor



- Range : 1 kVAr to 15 kVAr
- Voltage 415 V
- MPP SH, Resin Velled
- Low Watt loss

## Agri Boost Cylindrical Capacitors for Agriculture Applications

HSN Code: 85321000

Rating kVAr	Item Code	Description	Standard Pack No of unit/s	Master Pack No of unit/s	Per Unit LP (₹)
<b>Rated Voltage 415 V AC, 3φ, 50 Hz, Delta Connection</b>					
1 kVAr ▲	QHATCB5001X0	AGRI BOOST <sup>ND</sup> 415 V 50 Hz-1 kVAr 3 PH	1 N	16 N	396.00
2 kVAr ▲	QHATCB5002X0	AGRI BOOST <sup>ND</sup> 415 V 50 Hz-2 kVAr 3 PH	1 N	16 N	442.00
3 kVAr ▲	QHATCB5003X0	AGRI BOOST <sup>ND</sup> 415 V 50 Hz-3 kVAr 3 PH	1 N	16 N	650.00
4 kVAr ▲	QHATCB5004X0	AGRI BOOST <sup>ND</sup> 415 V 50 Hz-4 kVAr 3 PH	1 N	16 N	806.00
5 kVAr ▲	QHATCB5005X0	AGRI BOOST <sup>ND</sup> 415 V 50 Hz-5 kVAr 3 PH	1 N	16 N	968.00
6 kVAr ▲	QHATCB5006X0	AGRI BOOST <sup>ND</sup> 415 V 50 Hz-6 kVAr 3 PH	1 N	16 N	1165.00
7.5 kVAr	QHATCB5007X5	AGRI BOOST <sup>ND</sup> 415 V 50 Hz-7.5 kVAr 3 PH	1 N	16 N	1451.00
8 kVAr ▲	QHATCB5008X0	AGRI BOOST <sup>ND</sup> 415 V 50 Hz-8 kVAr 3 PH	1 N	16 N	1550.00
10 kVAr ▲	QHATCB5010X0	AGRI BOOST <sup>ND</sup> 415 V 50 Hz-10 kVAr 3 PH	1 N	16 N	1935.00
12.5 kVAr ▲	QHATCB5012X5	AGRI BOOST <sup>ND</sup> 415 V 50 Hz-12.5 kVAr 3 PH	1 N	8 N	2418.00
15 kVAr ▲	QHATCB5015X0	AGRI BOOST <sup>ND</sup> 415 V 50 Hz-15 kVAr 3 PH	1 N	8 N	2897.00

▲ Stockable Item

For details on technical parameters & non stockable items contact nearest sales office.

(IS: 13340)

Effective from 1st April, 2026

List Price (LP) are in Indian ₹ & as per Standard Terms & Conditions **HAVELLS 99**



Z:\HPL\00021\FEB26\MAR26

**REGIONAL & BRANCH OFFICES:**

**NORTH - REGIONAL OFFICE:** Corporate Office: QRG Towers, 2D, Sector-126, Expressway, Noida-201304, Tel: 0120-3331000, Delhi: 011-47676700, 23888200, Chandigarh: 0172-4232400-401, Dehradun: 0135-6670202, Haldwani: 05946-222935/222933, Noida / Haryana: 0120-3331000, Ludhiana: 0161-4676000/24, Amritsar: 0183-5202400/401, Jammu: 0191-2478330, 2479330, Sri Nagar: 0194-2459248, Jaipur: 0141-4211000, 4211011, Jodhpur: 9214201640/41, Lucknow: 0522- 4921600/4921649, Kanpur: 0512-6710400

**EAST - REGIONAL OFFICE:** Kolkata: ICC Tower, 5th Floor, 4 India Exchange Place, Kolkata-700001, Tel: 033-40129851/52, Bhubaneswar: 0674-6668101/102/103/104, Guwahati: 0361-2458923, 2134521, Siliguri: 0353-2525907, Ranchi: 0651-2244861, 2244862, 2244864, 2244868, 2244869, Jamshedpur: 0657-6542492, 09234369436, Patna: 0612-2207221, 2207222, 2207223, 2655518

**WEST - REGIONAL OFFICE:** 1271, Solitaire Corporate Park, Bldg. No. 12, 7th Floor, Andheri - Ghatkopar Link Road, Chakala, Andheri (East), Mumbai- 400093. Tel: 022 - 67298600-602, Ahmedabad: 079-40061111, 40060738/740, Indore: 0731-4219444/4219422, 0731-2572340, Rajkot: 0281-2481112, 2921212, Nagpur: 0712-2240932, 2242692, 2242699 Pune: 020-26056175-76, Raipur: 0771-4243400/01, Surat: 0261-2350137, 9979890137, Jabalpur: 0761-4064491, Bhopal: 0755-4271544, 0755-4011025,

**SOUTH - REGIONAL OFFICE:** Chennai: Sigapi Achi Building, No. 18 / 3, 6th Floor, Rukmani Lakshmi Pathy Road, Egmore, Chennai-600008, Tel: 044-42280600, 605, Bangalore: 080-49075000, Coimbatore: 0422-4550200/282, Hyderabad: 040-27533372, 27533355, 27533632, Cochin: 0484-4099000, Calicut: 0495-4019193/4/5, Trivandrum: 0471-4015323, Vizag: 0891-6514339, Vijayawada: 0866-2546161/62/67/68/69, Madurai: 0452-4267000, Hubli: 0836-4248660, Trichy: 0431-4041005/06

**Representative Offices:** • Goa • Solapur • Gwalior • Kathmandu • Bhopal • Kolapur • Vadodara

**Warranty Policy:**

All the products listed in the price list carry a warranty, against manufacturing defects for a period of 18\* months from the date of purchase / 12 months from the date of commissioning, whichever is earlier.

\*Proof of purchase to be retained to avail warranty.

**Terms & Conditions**

- Prices are in Indian ₹
- This Price List supersedes all our previous Price Lists.
- Prices are subject to change without notice.
- Company reserves the right to issue amendments, which may arise due to any errors in the price list.
- Prices are for quantity 1 N is equal to font height of LP value

Actual products may vary in colour, design, description and colour combination etc. Although every effort has been made to ensure accuracy in the compilation of the technical detail within this publication. Specifications & performance data are constantly changing.

“Copyright Subsists. Imitation of trade dress, graphics and color scheme of this document is a punishable offence.”

**Note:** All Products to be billed at 18% \*GST (Subject to change as per Govt. Notification).

**Havells India Ltd.**

Corp Office: QRG Towers, 2D, Sector-126, Expressway, Noida-201304 (U.P.)

Ph. +91-120-3331000, Email: marketing@havells.com, www.havells.com

Customer Care No.: 08045 77 1313

Join us on Facebook at [www.facebook.com/havells](http://www.facebook.com/havells) and share your ways to save planet!

CIN - L31900DL1983PLC016304

Scan the QR Code  
to download  
Havells mCatalogue

