



STANDARD

Performance Ka
Higher Standard



**BRING HOME STYLE
FOR YEARS TO COME**



YEARS
OF
TRUST **60**

SWITCHES LIST PRICE
w.ef. 16th April 2026



Brushed Metal Bronze

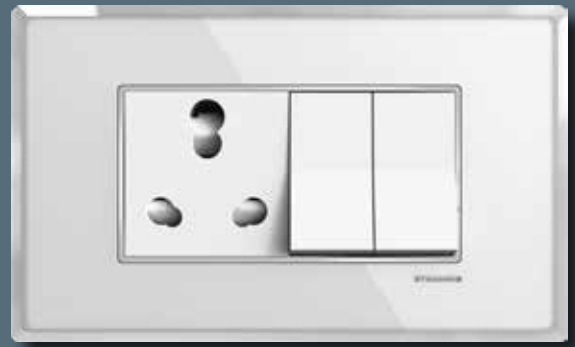

Misty White



Mahogany Wood





True
Elegance



Soft action
switches



Safe Round
Corner



Durability



ALINA

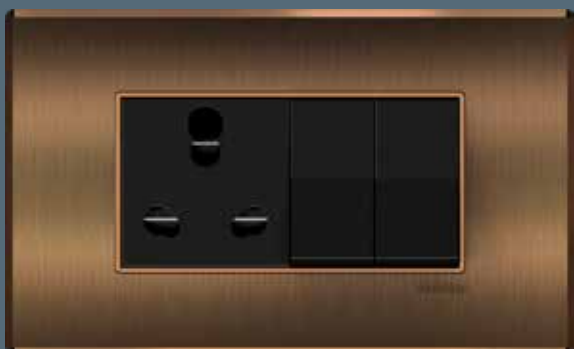

Brushed Metal Bronze



Brushed Metal Silver



Mahogany Wood

Alina Glass Plate	1 M	2 M	3 M	4 M
Steely Grey	ASAPGAGV01	ASAPGAGV02	ASAPGAGV03	ASAPGAGV04
Misty White	ASAPGAWV01	ASAPGAWV02	ASAPGAWV03	ASAPGAWV04
List Price	₹ 663	₹ 663	₹ 816	₹ 965
Birch Brown	ASAPGATV01	ASAPGATV02	ASAPGATV03	ASAPGATV04
List Price	₹ 583	₹ 583	₹ 742	₹ 837
Std./Master Packing (No. of Unit/s)	3 N / 12 N	3 N / 12 N	3 N / 12 N	3 N / 12 N
Alina Metal Plate	1 M	2 M	3 M	4 M
Brushed Metal Bronze	ASAPMAKV01	ASAPMAKV02	ASAPMAKV03	ASAPMAKV04
Brushed Metal Silver	ASAPMASV01	ASAPMASV02	ASAPMASV03	ASAPMASV04
List Price	₹ 1007	₹ 1007	₹ 1113	₹ 1246
Std./Master Packing (No. of Unit/s)	3 N / 12 N	3 N / 12 N	3 N / 12 N	3 N / 12 N
Alina Wood Plate	1 M	2 M	3 M	4 M
Mahogany Wood	ASAPWAMV01	ASAPWAMV02	ASAPWAMV03	ASAPWAMV04
List Price	₹ 1007	₹ 1007	₹ 1113	₹ 1246
Std./Master Packing (No. of Unit/s)	3 N / 12 N	3 N / 12 N	3 N / 12 N	3 N / 12 N



Birch Brown

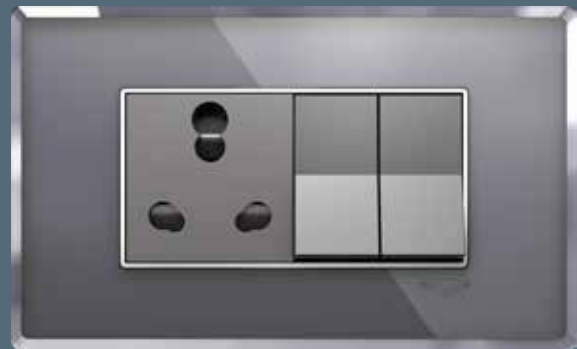

Steely Grey

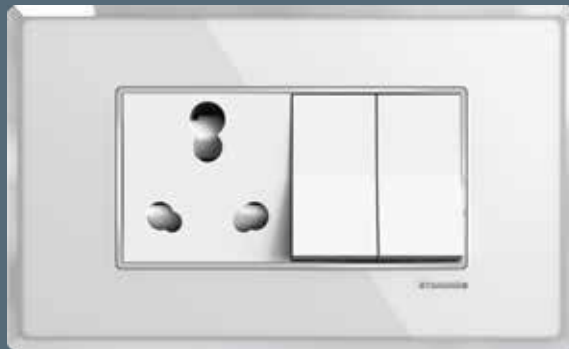

Misty White

	6 M	8 M (V)	8 M (H)	12 M	18 M
	ASAPGAGV06	ASAPGAGV08	ASAPGAGH08	ASAPGAGV12	ASAPGAGV18
	ASAPGAWV06	ASAPGAWV08	ASAPGAWH08	ASAPGAWV12	ASAPGAWV18
	₹ 1060	₹ 1330	₹ 1330	₹ 1749	₹ 2333
	ASAPGATV06	ASAPGATV08	ASAPGATH08	ASAPGATV12	ASAPGATV18
	₹ 1049	₹ 1177	₹ 1177	₹ 1643	₹ 2417
	3 N / 12 N	3 N / 12 N	3 N / 12 N	3 N / 9 N	3 N / 6 N
	6 M	8 M (V)	8 M (H)	12 M	18 M
	ASAPMAKV06	ASAPMAKV08	ASAPMAKH08	ASAPMAKV12	ASAPMAKV18
	ASAPMASV06	ASAPMASV08	ASAPMASH08	ASAPMASV12	ASAPMASV18
	₹ 1431	₹ 1749	₹ 1749	₹ 2491	₹ 4240
	3 N / 12 N	3 N / 12 N	3 N / 12 N	3N / 9N	3 N / 6 N
	6 M	8 M (V)	8 M (H)	12 M	18 M
	ASAPWAMV06	ASAPWAMV08	ASAPWAMH08	ASAPWAMV12	ASAPWAMV18
	₹ 1431	₹ 1749	₹ 1749	₹ 2491	₹ 4240
	3 N / 12 N	3 N / 12 N	3 N / 12 N	3 N / 9 N	3 N / 6 N

SWITCH MODULE - ALINA WHITE, GREY & BLACK



6 AX 1 Way
Switch



16 AX 1 Way
Switch



16 AX 1 Way
Switch W. Ind.



6 AX 2 Way
Switch



6 A Bell Push
Switch



6 A Bell Push
Switch W. Ind.



32 A DP Switch with
Ind.



6 A Mega BP Switch
W. Ind.

FAN REGULATOR - ALINA WHITE, GREY & BLACK



1 M Fan
Regulator Alina



2 M Fan
Regulator Alina

Item Name	Std./Master Packing (No. of Unit/s)	SAP Code	List Price in ₹ Per Unit	SAP Code	List Price in ₹ Per Unit	SAP Code	List Price in ₹ Per Unit
		WHITE MODULE		GREY MODULE		BLACK MODULE	
6 AX One Way Switch Alina	20 N / 400 N	ASASXXW061	₹ 41	ASASXXG061	₹ 52	ASASXXB061	₹ 52
16 AX One Way Switch Alina	20 N / 120 N	ASASXXW161	₹ 129	ASASXXG161	₹ 167	ASASXXB161	₹ 167
6 AX Two Way Switch Alina	20 N / 120 N	ASASXXW062	₹ 119	ASASXXG062	₹ 139	ASASXXB062	₹ 139
16 AX One Way Switch With Ind. Alina	20 N / 120 N	ASASXIW161	₹ 153	ASASXIG161	₹ 198	ASASXIB161	₹ 198
6 A Bell Push Switch Alina	20 N / 60 N	ASASBXW061	₹ 172	ASASBXG061	₹ 204	ASASXBB061	₹ 204
6 A Bell Push Switch With Ind. Alina	20 N / 60 N	ASASBIW061	₹ 190	ASASBIG061	₹ 225	ASASBIB061	₹ 225
6 A Mega Bp Switch With Ind. Alina	10 N / 30 N	ASAMBIW061	₹ 237	ASAMBIG061	₹ 278	ASAMBIB061	₹ 278
32 A DP Switch With Indicator Alina	10 N / 30 N	ASASDIW321	₹ 482	ASASDIG321	₹ 536	ASASDIB321	₹ 536

Item Name	Std./Master Packing (No. of Unit/s)	SAP Code	List Price in ₹ Per Unit	SAP Code	List Price in ₹ Per Unit	SAP Code	List Price in ₹ Per Unit
		WHITE MODULE		GREY MODULE		BLACK MODULE	
1 M Fan Regulator Alina	20 N / 160 N	ASARFXW004	₹ 363	ASARFXG004	₹ 471	ASARFXB004	₹ 471
2 M Fan Regulator Alina	10 N / 80 N	ASARFXW005	₹ 444	ASARFXG005	₹ 577	ASARFXB005	₹ 577



Alina White

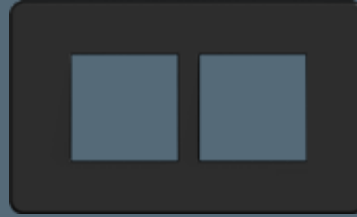

Alina Black

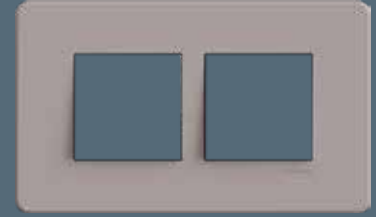

Alina Grey



Alina Wood Finish Wenge



Alina Wood Finish Walnut

Alina Combined Plate	1 M	2 M	3 M	4 M
White	ASZPLAWV01	ASZPLAWV02	ASZPLAWV03	ASZPLAWV04
List Price	₹ 87.00	₹ 87.00	₹ 116.00	₹ 133.00
Grey	ASAPLAGV01	ASAPLAGV02	ASAPLAGV03	ASAPLAGV04
Black	ASAPLABV01	ASAPLABV02	ASAPLABV03	ASAPLABV04
List Price	₹ 109.00	₹ 109.00	₹ 145.00	₹ 169.00
Std./Master Packing (No. of Unit/s)	5 N / 40 N	5 N / 80 N	5 N / 80 N	5 N / 80 N
Alina Wood Finish Combined Plate	1 M	2 M	3 M	4 M
American Wenge	ASAPLADV01	ASAPLADV02	ASAPLADV03	ASAPLADV04
American Walnut	ASAPLAAV01	ASAPLAAV02	ASAPLAAV03	ASAPLAAV04
List Price	₹ 130.00	₹ 130.00	₹ 180.00	₹ 205.00
Std./Master Packing (No. of Unit/s)	5 N / 40 N	5 N / 80 N	5 N / 80 N	5 N / 80 N
Alina Glass Finish Combined Plate	1 M	2 M	3 M	4 M
Red Wine	ASAPTARV01	ASAPTARV02	ASAPTARV03	ASAPTARV04
Sea Green	ASAPTAOV01	ASAPTAOV02	ASAPTAOV03	ASAPTAOV04
White	ASAPTAWV01	ASAPTAWV02	ASAPTAWV03	ASAPTAWV04
Black	ASAPTABV01	ASAPTABV02	ASAPTABV03	ASAPTABV04
List Price	₹ 261.00	₹ 261.00	₹ 312.00	₹ 374.00
Std./Master Packing (No. of Unit/s)	2 N / 12 N / 24 N	2 N / 12 N / 24 N	2 N / 12 N / 24 N	2 N / 9 N / 18 N



Alina Glass Finish Wine



Alina Glass Finish White



Alina Glass Finish Sea Green



Alina Glass Finish Black

	6 M	8 M (V)	8 M (H)	9 M	12 M	16 M	18 M
	ASZPLAWV06	ASZPLAWV08	ASZPLAWH08	ASZPLAWV09	ASZPLAWV12	ASZPLAWV16	ASZPLAWV18
	₹ 195.00	₹ 248.00	₹ 248.00	₹ 270.00	₹ 298.00	₹ 326.00	₹ 343.00
	ASAPLAGV06	ASAPLAGV08	ASAPLAGH08	ASAPLAGV09	ASAPLAGV12	ASAPLAGV16	ASAPLAGV18
	ASAPLABV06	ASAPLABV08	ASAPLABH08	ASAPLABV09	ASAPLABV12	ASAPLABV16	ASAPLABV18
	₹ 246.00	₹ 312.00	₹ 312.00	₹ 339.00	₹ 378.00	₹ 403.00	₹ 424.00
	5 N / 80 N	5 N / 60 N	5 N / 60 N	5 N / 60 N	5 N / 30 N	5 N / 30 N	5 N / 30 N
	6 M	8 M (V)	8 M (H)		12 M	16 M	18 M
	ASAPLADV06	ASAPLADV08	ASAPLADH08	ASAPLADV09	ASAPLADV12	ASAPLADV16	ASAPLADV18
	ASAPLAAV06	ASAPLAAV08	ASAPLAAH08	ASAPLAAV09	ASAPLAAV12	ASAPLAAV16	ASAPLAAV18
	₹ 305.00	₹ 385.00	₹ 385.00	₹ 420.00	₹ 460.00	₹ 510.00	₹ 535.00
	5 N / 80 N	5 N / 60 N	5 N / 60 N	5 N / 60 N	5 N / 30 N	5 N / 30 N	5 N / 30 N
	6 M	8 M (V)	8 M (H)		12 M	16 M	18 M
	ASAPTARV06	ASAPTARV08	ASAPTARH08	ASAPTARV09	ASAPTARV12	ASAPTARV16	ASAPTARV18
	ASAPTAOV06	ASAPTAOV08	ASAPTAOH08	ASAPTAOV09	ASAPTAOV12	ASAPTAOV16	ASAPTAOV18
	ASAPTAWV06	ASAPTAWV08	ASAPTAWH08	ASAPTAWV09	ASAPTAWV12	ASAPTAWV16	ASAPTAWV18
	ASAPTABV06	ASAPTABV08	ASAPTABH08	ASAPTABV09	ASAPTABV12	ASAPTABV16	ASAPTABV18
	₹ 509.00	₹ 673.00	₹ 673.00	₹ 787.00	₹ 819.00	₹ 1075.00	₹ 1125.00
	2 N / 9 N / 18 N	2 N / 9 N / 18 N	2 N / 6 N / 12 N	2 N / 9 N / 18 N	2 N / 6 N / 12 N	2 N / 6 N / 12 N	2 N / 6 N / 12 N

SWITCH MODULE - ZOE WHITE, GREY & BLACK



10 A 1-Way Switch



10 A 2-Way Switch



10 A 1-Way Switch ind.



10 A Bell Push Switch



10 A 1-Way Mega bell push ind.



32 A DP Switch with ind.

SOCKET MODULE - ZOE WHITE, GREY & BLACK



6 A 3 Pin Socket



6 A / 16 A Socket

HOSPITALITY RANGE - ZOE WHITE, GREY & BLACK



20 A Key tag with time delay



30 A Key tag Mechanical



DND and MMR outdoor pane



MMR Indoor panel



Shaver Socket

Item Name	Std./Master Packing (No. of Unit/s)	SAP Code	List Price in ₹ Per Unit	SAP Code	List Price in ₹ Per Unit	SAP Code	List Price in ₹ Per Unit
		WHITE MODULE		GREY MODULE		BLACK MODULE	
6 A One way switch	20 N / 400 N	ASZSPXW061	₹ 34.00	ASZSPXG061	₹ 42.00	ASZSPXB061	₹ 42.00
10 A Two way switch	20 N / 120 N	ASZSPXW102	₹ 111.00	ASZSPXG102	₹ 129.00	ASZSPXB102	₹ 129.00
10 A One way switch with indicator	20 N / 60 N	ASZSPIW101	₹ 174.00	ASZSPIG101	₹ 202.00	ASZSPIB101	₹ 202.00
10 A Bell push switch	20 N / 60 N	ASZSBXW100	₹ 161.00	ASZSBXG100	₹ 190.00	ASZSBXB101	₹ 190.00
10 A Bell push switch with indicator	20 N / 60 N	ASZSBIW100	₹ 177.00	ASZSBIG100	₹ 211.00	ASZSBIB101	₹ 211.00
10 A Mega BP switch with indicator	10 N / 30 N	ASZMBIW100	₹ 228.00	ASZMBIG100	₹ 258.00	ASZMBIB100	₹ 258.00
16 A One way switch	20 N / 120 N	ASZSPXW161	₹ 124.00	ASZSPXG161	₹ 156.00	ASZSPXB161	₹ 156.00
16 A Two way switch	20 N / 60 N	ASZSPXW162	₹ 236.00	ASZSPXG162	₹ 276.00	ASZSPXB162	₹ 276.00
16 A One way switch with indicator	20 N / 120 N	ASZSPIW161	₹ 148.00	ASZSPIG161	₹ 190.00	ASZSPIB161	₹ 190.00
32 A DP Switch with indicator	10 N / 30 N	ASZSDIW320	₹ 453.00	ASZSDIG320	₹ 503.00	ASZSDIB321	₹ 503.00

Item Name	Std./Master Packing (No. of Unit/s)	SAP Code	List Price in ₹ Per Unit	SAP Code	List Price in ₹ Per Unit	SAP Code	List Price in ₹ Per Unit
		WHITE MODULE		GREY MODULE		BLACK MODULE	
6 A 3 pin socket	10 N / 30 N	ASZKPXW063	₹ 109.00	ASZKPXG063	₹ 140.00	ASZKPB063	₹ 140.00
6 A / 16 A Socket	10 N / 60 N	ASZKCXW163	₹ 192.00	ASZKCXG163	₹ 249.00	ASZKCB163	₹ 249.00
6 A / 16 A Raised Socket	10 N / 60 N	ASZKRXW163	₹ 192.00	ASZKRXG163	₹ 249.00	ASZKRXB163	₹ 249.00
16 A Heavy Duty Socket	10 N / 30 N	ASZKCXW253	₹ 316.00	ASZKCXG253	₹ 367.00	ASZKCB253	₹ 367.00

Item Name	Std./Master Packing (No. of Unit/s)	SAP Code	List Price in ₹ Per Unit	SAP Code	List Price in ₹ Per Unit	SAP Code	List Price in ₹ Per Unit
		WHITE MODULE		GREY MODULE		BLACK MODULE	
30 A Key tag Mechanical	18 N	ASZSEXW000	₹ 874.00	ASZSEXG000	₹ 1010.00	ASZSEXB000	₹ 1010.00
20 A Key tag with time delay	60 N	ASZSEIW000	₹ 2271.00	ASZSEIG000	₹ 2649.00	ASZSEIB000	₹ 2649.00
DND and MMR outdoor panel	20 N / 60 N	ASZSXDW101	₹ 775.00	ASZSXDG101	₹ 906.00	ASZSXDB101	₹ 906.00
DND door panel 2 Way Switch	20 N / 60 N	ASZSXDW102	₹ 337.00	ASZSXDG102	₹ 393.00	ASZSXDB102	₹ 393.00
MMR Switch 1 Way	20 N / 60 N	ASZIPIW060	₹ 272.00	ASZIPIG060	₹ 317.00	ASZIPIB060	₹ 317.00
Shaver socket	1 N	ASZKEXW162	₹ 2044.00	ASZKEXG162	₹ 2468.00	ASZKEXB162	₹ 2468.00

* MTO (Product will be available against order as per lead time).

SUPPORT MODULE - ZOE WHITE, GREY & BLACK



Indicator



Blank Plate



Buzzer



Fan Regulator 1 M



Fan Regulator 2 M

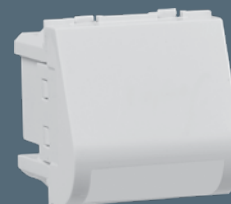

Footlight

COMMUNICATION MODULES - ZOE WHITE, GREY & BLACK



Telephone socket



Computer Jack



TV Socket



USB Socket for data transmission

MOTOR STARTER & MINI MCB - ZOE WHITE, GREY & BLACK



20 A Motor Starter



25 A Motor Starter



32 A Motor Starter



20 A Mini MCB



25 A Mini MCB



32 A Mini MCB

Item Name	Std./Master Packing (No. of Unit/s)	SAP Code	List Price in ₹ Per Unit	SAP Code	List Price in ₹ Per Unit	SAP Code	List Price in ₹ Per Unit
		WHITE MODULE		GREY MODULE		BLACK MODULE	
Indicator lamp	20 N / 60 N	ASZSIW061	₹ 95.00	ASZSII061	₹ 112.00	ASZSIB061	₹ 112.00
Dummy plate - 1 Module	20 N / 120 N	ASZPLBWW01	₹ 20.00	ASZPLBGV01	₹ 29.00	ASZPLBBV01	₹ 29.00
Footlight	9 N / 54 N	ASZPFCWW02	₹ 683.00	ASZPFCGV02	₹ 800.00	ASZPFCBV02	₹ 800.00
Buzzer	10 N / 30	ASZBXXW002	₹ 328.00	ASZBXXG002	₹ 398.00	ASZBXXB002	₹ 398.00
1 Module Step Fan Reg.	20 N / 160 N	ASZRFXXW004	₹ 347.00	ASZRFXG004	₹ 450.00	ASZRFXB004	₹ 450.00
2 Module Step Fan Reg.	10 N / 80 N	ASZRFXXW005	₹ 427.00	ASZRFXG005	₹ 553.00	ASZRFXB005	₹ 553.00

Item Name	Std./Master Packing (No. of Unit/s)	SAP Code	List Price in ₹ Per Unit	SAP Code	List Price in ₹ Per Unit	SAP Code	List Price in ₹ Per Unit
		WHITE MODULE		GREY MODULE		BLACK MODULE	
Telephone socket - 1 Module	20 N / 60 N	ASZKNWW111	₹ 171.00	ASZKNWG111	₹ 198.00	ASZKNXB111	₹ 198.00
Computer Jack	20 N / 60 N	ASZKNWW451	₹ 553.00	ASZKNWG451	₹ 645.00	ASZKNXB451	₹ 645.00
TV Socket	20 N / 60 N	ASZKTOW001	₹ 154.00	ASZKTG001	₹ 183.00	ASZKTXB001	₹ 183.00
USB Socket 2.1 A Single Port	20 N / 60 N	ASZKGXW002	₹ 1068.00	ASZKGXG002	₹ 1244.00	ASZKGB002	₹ 1244.00
USB Socket 2.1 A Single Port Type C	20 N / 60 N	ASZKRXXW002	₹ 951.00	ASZKRXXG002	₹ 1186.00	ASZKRXB002	₹ 1186.00

Item Name	Std./Master Packing (No. of Unit/s)	SAP Code	List Price in ₹ Per Unit	SAP Code	List Price in ₹ Per Unit		
		WHITE MODULE		GREY MODULE		BLACK MODULE	
20 A Motor Starter	10 N / 100 N	ASZSMXW201	₹ 552.00	ASZSMXG201	₹ 644.00	ASZSMXB201	₹ 644.00
25 A Motor Starter	10 N / 100 N	ASZSMXW251	₹ 572.00	ASZSMXG251	₹ 654.00	ASZSMXB251	₹ 654.00
32 A Motor Starter	10 N / 100 N	ASZSMXW321	₹ 635.00	ASZSMXG321	₹ 708.00	ASZSMXB321	₹ 708.00
10 A SP 'C' MINI MCB	12 N / 240 N	DSZNCSPA010	₹ 293.00	DSZNCSPA01000MR	₹ 342.00	DSZNCSPA01000EB	₹ 342.00
16 A SP 'C' MINI MCB	12 N / 240 N	DSZNCSPA016	₹ 293.00	DSZNCSPA01600MR	₹ 342.00	DSZNCSPA01600EB	₹ 342.00
20 A SP 'C' MINI MCB	12 N / 240 N	DSZNCSPA020	₹ 300.00	DSZNCSPA02000MR	₹ 352.00	DSZNCSPA02000EB	₹ 352.00
25 A SP 'C' MINI MCB	12 N / 240 N	DSZNCSPA025	₹ 300.00	DSZNCSPA02500MR	₹ 352.00	DSZNCSPA02500EB	₹ 352.00
32 A SP 'C' MINI MCB	12 N / 240 N	DSZNCSPA032	₹ 311.00	DSZNCSPA03200MR	₹ 361.00	DSZNCSPA03200EB	₹ 361.00



White Chrome

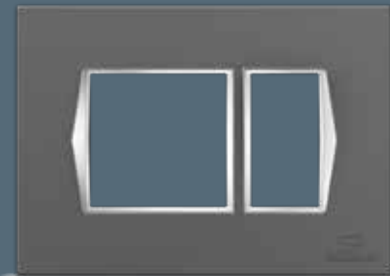

Grey Chrome

Zoe Chrome Combined Plate	1 M	2 M	3 M	4 M	
White Chrome	ASZPLCCV01	ASZPLCCV02	ASZPLCCV03	ASZPLCCV04	
List Price	₹ 126.00	₹ 126.00	₹ 138.00	₹ 171.00	
Grey Chrome	ASZPLOGV01	ASZPLOGV02	ASZPLOGV03	ASZPLOGV04	
List Price	₹ 161.00	₹ 161.00	₹ 178.00	₹ 218.00	
Std./Master Packing (No. of Unit/s)	5 N / 40 N	5 N / 40 N	5 N / 60 N	5 N / 80 N	





White Chrome

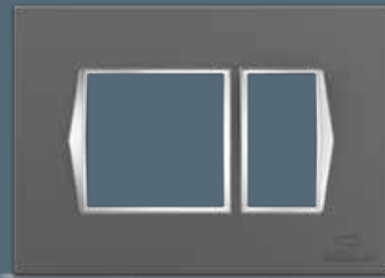

Grey Chrome

	6 M	8 M (V)	8 M (H)	9 M	12 M	16 M	18 M
	ASZPLCCV06	ASZPLCCV08	ASZPLCCH08	ASZPLCCV09	ASZPLCCV12	ASZPLCCV16	ASZPLCCV18
	₹ 232.00	₹ 304.00	₹ 304.00	₹ 349.00	₹ 354.00	₹ 431.00	₹ 504.00
	ASZPLOGV06	ASZPLOGV08	ASZPLOGH08	ASZPLOGV09	ASZPLOGV12	ASZPLOGV16	ASZPLOGV18
	₹ 302.00	₹ 388.00	₹ 388.00	₹ 435.00	₹ 457.00	₹ 596.00	₹ 649.00
	5 N / 60 N	5 N / 40 N	5 N / 40 N	5 N / 40 N	5 N / 40 N	5 N / 40 N	5 N / 30 N



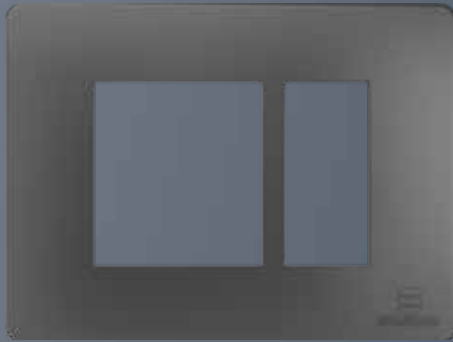

Grey

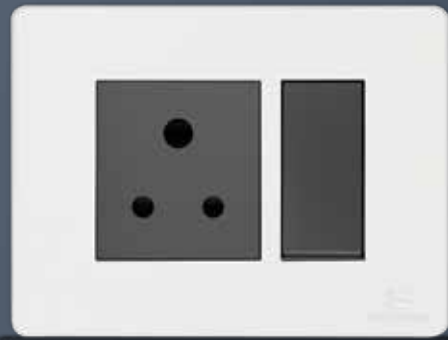

White



Enhance your walls with the perfect blend of solid colours and metallic smoothness, creating an elegant ambiance.



IVY 

SWITCH MODULE - IVY GREY & WHITE



10 AX 1-Way Switch



10 AX 2-Way Switch



10 AX 1-Way Switch ind.



10 A Bell Push Switch ind.



10 AX 2-Way Mega Switch



10 AX 1-Way Mega Switch ind.



10 A 1-Way Mega bell push ind.



10 A 1-Way Switch



10 A 2-Way Switch



10 A 1-Way Switch ind.



10 A Bell Push Switch ind.



10 A 1-Way Mega Switch



10 A 1-Way Mega Switch ind.



10 A 1-Way Mega bell push ind.

SOCKET MODULE - IVY GREY & WHITE



6 A 3 Pin Socket



6 A / 16 A Socket



6 A 3 Pin Socket



6 A / 16 A Socket

SUPPORT MODULE - IVY GREY & WHITE



Indicator



T.V. Socket



RJ 11 Shutter



RJ 45



Blank Plate



Fan Regulator 1 Module



Fan Regulator 2 Module



Dimmer



Indicator



T.V. Socket



RJ 11 Shutter



RJ 45



Blank Plate



Fan Regulator 1 Module



Fan Regulator 2 Module



Dimmer

Item Name	Std./Master Packing (No. of Unit/s)	SAP Code	List Price in ₹ Per Unit	SAP Code	List Price in ₹ Per Unit
		WHITE MODULE		GREY MODULE	
10 A 1-Way Switch	20 N / 400 N	ASYSXXW101	₹ 64.00	ASYSXXG101	₹ 72.00
10 A 2-Way Switch	20 N / 120 N	ASYSXXW102	₹ 162.00	ASYSXXG102	₹ 192.00
10 A 1-Way Switch Indicator	20 N / 60 N	ASYSXIW101	₹ 180.00	ASYSXIG101	₹ 200.00
10 A Bell Push Switch	20 N / 60 N	ASYSBXW101	₹ 173.00	ASYSBXG101	₹ 202.00
10 A Bell Push Switch Indicator	20 N / 60 N	ASYSBIW101	₹ 188.00	ASYSBIG101	₹ 220.00
16 A 1-Way Switch	20 N / 120 N	ASYSXXW161	₹ 168.00	ASYSXXG161	₹ 198.00
16 A 1-Way Switch Indicator	20 N / 120 N	ASYSXIW161	₹ 205.00	ASYSXIG161	₹ 239.00
25 A 1-Way Switch	20 N / 60 N	ASYSXXW251	₹ 288.00	ASYSXXG251	₹ 355.00
10 A 1-Way Mega Bell Push Indicator	10 N / 30 N	ASYMBIW101	₹ 239.00	ASYMBIG101	₹ 284.00
32 A D.P. Switch with Indicator	10 N / 30 N	ASYSDXW321	₹ 521.00	ASYSDIG321	₹ 611.00

Item Name	Std./Master Packing (No. of Unit/s)	SAP Code	List Price in ₹ Per Unit	SAP Code	List Price in ₹ Per Unit
		WHITE MODULE		GREY MODULE	
6 A 3 Pin Socket	10 N / 30 N	ASYKPWW063	₹ 153.00	ASYKPKG063	₹ 178.00
6 A / 16 A Socket	10 N / 60 N	ASYKCVW063	₹ 285.00	ASYKXG163	₹ 332.00
16 A Heavy Duty Socket	10 N / 30 N	ASYKCVW253	₹ 364.00	ASYKXG253	₹ 424.00

Item Name	Std./Master Packing (No. of Unit/s)	SAP Code	List Price in ₹ Per Unit	SAP Code	List Price in ₹ Per Unit
		WHITE MODULE		GREY MODULE	
Blank Plate 1 Module	20 N / 120 N	ASYPLBWX01	₹ 35.00	ASYPLBGV01	₹ 52.00
Fan Regulator 5 Step 2 Module	10 N / 80 N	ASYRFXW002	₹ 629.00	ASYRFHG005	₹ 735.00
Fan Regulator 4 Step 1 Module	20 N / 160 N	ASYRFXW001	₹ 549.00	ASYRFXG004	₹ 643.00
Indicator Lamp *	20 N / 60 N	ASYSIOW061	₹ 131.00	ASYIPIG060	₹ 153.00
RJ 11 with Shutter *	20 N / 60 N	ASYKRWW111	₹ 193.00	ASYKNWG111	₹ 225.00
T.V. Socket Ivy *	20 N / 60 N	ASYKTOW061	₹ 177.00	ASYKTXG001	₹ 208.00
RJ 45 Mounting With Jack (CAT6) *	20 N / 60 N	ASYKJWW451	₹ 644.00	ASYKRWG451	₹ 754.00
Buzzer*	10 N / 30 N	ASYBXXW000	₹ 408.00	ASYBXXG000	₹ 479.00
LED Footlight 2 Module *	9 N / 54 N	ASYPFCWV02	₹ 792.00	ASYPFCGV02	₹ 927.00
USB Charger 2.1 A Single Port*	10 N / 30 N	ASYKGXW002	₹ 1239.00	ASYKXG002	₹ 1449.00

MOTOR STARTER - IVY GREY & WHITE



20 A Motor Starter



25 A Motor Starter



20 A Motor Starter



25 A Motor Starter

MINI MCB - IVY GREY & WHITE



10 A SP 'C' Mini MCB



25 A SP 'C' Mini MCB



32 A SP 'C' Mini MCB



6 A SP 'C' Mini MCB



25 -A SP 'C' Mini MCB



10 A SP 'C' Mini MCB



White

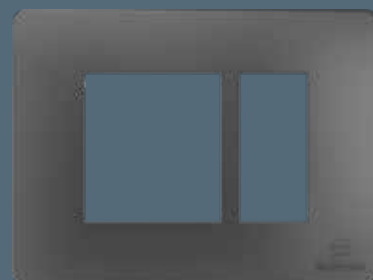

Grey

Ivy Combined Plate - White PC	1 M	2 M	3 M	4 M	6 M
Ivy White	ASYPLCWV01	ASYPLCWV02	ASYPLCWV03	ASYPLCWV04	ASYPLCWV06
List Price	₹ 133.00	₹ 133.00	₹ 155.00	₹ 193.00	₹ 263.00
Ivy Combined Plates - Metallic Paint Finish	1 M	2 M	3 M	4 M	6 M
Ivy Grey *	ASYPLCGV01	ASYPLCGV02	ASYPLCGV03	ASYPLCGV04	ASYPLCGV06
List Price	₹ 169.00	₹ 169.00	₹ 196.00	₹ 241.00	₹ 333.00
Std./Master Packing (No. of Unit/s)	5 N / 40 N	5 N / 40 N	5 N / 60 N	5 N / 80 N	5 N / 60 N

Item Name	Std./Master Packing (No. of Unit/s)	SAP Code	List Price in ₹ Per Unit	SAP Code	List Price in ₹ Per Unit
		WHITE MODULE		GREY MODULE	
20 A Motor Starter*	10 N / 100 N	ASYSMXW201	₹ 629.00	ASYSMXG201	₹ 737.00
25 A Motor Starter	10 N / 100 N	ASYSMXW251	₹ 644.00	ASYSMXG251	₹ 754.00
32 A Motor Starter	10 N / 100 N	ASYSMXW321	₹ 670.00	ASYSMXG321	₹ 791.00

Item Name	Std./Master Packing (No. of Unit/s)	SAP Code	List Price in ₹ Per Unit	SAP Code	List Price in ₹ Per Unit
		WHITE MODULE		GREY MODULE	
6 A SP 'C' Mini MCB Ivy*	12 N / 240 N	DSYNCSA006	₹ 340.00	DSYNCSA00600MR	₹ 397.00
10 A SP 'C' Mini MCB Ivy*	12 N / 240 N	DSYNCSA010	₹ 340.00	DSYNCSA01000MR	₹ 397.00
16 A SP 'C' Mini MCB Ivy*	12 N / 240 N	DSYNCSA016	₹ 340.00	DSYNCSA01600MR	₹ 397.00
20 A SP 'C' Mini MCB Ivy	12 N / 240 N	DSYNCSA020	₹ 340.00	DSYNCSA02000MR	₹ 397.00
25 A SP 'C' Mini MCB Ivy	12 N / 240 N	DSYNCSA025	₹ 340.00	DSYNCSA02500MR	₹ 397.00
32 A SP 'C' Mini MCB Ivy	12 N / 240 N	DSYNCSA032	₹ 340.00	DSYNCSA03200MR	₹ 397.00



White

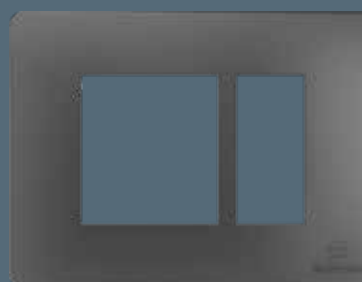

Grey

	8 M (V)	8 M (H)	9 M	12 M	16 M	18 M
	ASYPLCWV08	ASYPLCWH08	ASYPLCWV09	ASYPLCWV12	ASYPLCWV16	ASYPLCWV18
	₹ 348.00	₹ 348.00	₹ 384.00	₹ 393.00	₹ 462.00	₹ 486.00
	8 M (V)	8 M (H)	9 M	12 M	16M	18 M
	ASYPLCGV08	ASYPLCGH08	ASYPLCGV09	ASYPLCGV12	ASYPLCGV16	ASYPLCGV18
	₹ 429.00	₹ 429.00	₹ 481.00	₹ 496.00	₹ 586.00	₹ 614.00
	5 N / 40 N	5 N / 40 N	--	5 N / 40 N	5 N / 40 N	5 N / 30 N

ACCESSORIES & BOXES





ACCESSORIES & BOXES

List Price w.e.f. 16th April, 2026

SMART PLUGS - WiFi



Smart Plug 10 A WiFi



Smart Plug 16 A WiFi

LAMP HOLDERS



Fancy Angle Holder
(Metal Ring)



Fancy Batten Holder
(Metal Ring)



Fancy Jumbo Batten
Holder (Metal Ring)



Pendant Holder -
(Metal Ring)

PLUG TOPS & ADAPTORS



6 A 3 pin Plug



16 A 3 pin Plug



6 A 2 Pin Adaptor



6 A 3 Pin Adaptor



16 A 3 Pin Adaptor

EXTENSION CORDS & DOOR BELL



QNEST - 4 way Surge &
Spike Guard (1.5 m)





Reel-O 2 Pin 5 m Flexbox





Sprinklar Water Alarm Bell



Musica Ding Dong Bell

Item Name	Std./Master Packing (No. of Unit/s)	SAP Code	List Price in ₹ Per Unit
10 A Smart Plug With WiFi 	1 / 20 N	ASST101003	₹ 1256.00
16 A Smart Plug With WiFi 	1 / 20 N	ASST161603	₹ 1449.00

Item Name	Std./Master Packing (No. of Unit/s)	SAP Code	List Price in ₹ Per Unit
Pendant Holder - (Metal Ring)	50 N / 400 N	ASYHEXW061	₹ 41.00
Fancy Angle Holder(Metal Ring)	30 N / 240 N	ASYHQMW021	₹ 45.00
Fancy Batten Holder(Metal Ring)	30 N / 240 N	ASYHRMW021	₹ 45.00
Fancy Jumbo Batten Holder (Metal Ring)	10 N/ 100 N	ASYHSMW021	₹ 62.00

Item Name	Std./Master Packing (No. of Unit/s)	SAP Code	List Price in ₹ Per Unit
6 A 3 pin Plug 	10 N / 120 N	ASYGXXW063	₹ 67.00
16 A 3 pin Plug 	10 N / 120 N	ASYGXXW163	₹ 98.00
16 A 3 Pin plug Heavy Duty	10 N / 120 N	ASYGXXW253	₹ 120.00
6 A 3 Pin plug with Indicator	10 N / 120 N	ASYGLXW063	₹ 82.00
16 A 3 Pin plug with Indicator	10 N / 120 N	ASYGLXW163	₹ 109.00
6 A 3 pin Universal Adaptor with Indicator	10 N / 60 N	ASYMUXW063	₹ 160.00
6 A 16 A 3 pin Adaptor	10 N / 40 N	ASYMUXW163	₹ 185.00

* Limited Stock, Sale depends upon availability of the product

Item Name	Std./Master Packing (No. of Unit/s)	SAP Code	List Price in ₹ Per Unit
QNEST - 4 way Surge & Spike Guard (1.5 m)	1 N / 10 N	ASNKXXW061	₹ 528.00
Reel-O 2 Pin 5 m Flexbox	1 N / 20 N	ASEXXXU065	₹ 502.00
Musica Ding Dong Bell	1 N / 10 N	ASYYYXW001	₹ 331.00
Sprinklar Water Conservation Alarm Bell	1 / 20 N	ASNLEXW000	₹ 465.00



CEILING ROSE



Ceiling Rose - Mini



Ceiling Rose - Mini



Ceiling Rose - Jumbo

GI BOXES FLUSH METAL



SURFACE MOUNTING PLASTIC BOXES



Item Name	Std./Master Packing (No. of Unit/s)	SAP Code	List Price in ₹ Per Unit
Ceiling Rose 3 plate Mini Square	30 N / 360 N	ASYGCXW000	₹ 36.00
Ceiling Rose 2 plate Jumbo Square	20 N / 240 N	ASYGXXW000	₹ 41.00
Ceiling Rose 2 plate Mini Round	20 N / 240 N	ASYGCXW001	₹ 31.00

Item Name	Std./Master Packing (No. of Unit/s)	Size (cm) / inch	SAP Code	List Price in ₹ Per Unit
1/2 Module GI Box NDN 0.8 mm	60 N	(7.6x7.6) cm / (3 x 3)	ASIXMIAX01	₹ 42
3 Module GI Box NDN 0.8 mm	40 N	(10.58x7.6) cm / (4 x 3)	ASIXMIAX03	₹ 57
4 Module GI Box NDN 0.8 mm	30 N	(13.56x7.6) cm / (5 x 3)	ASIXMIAX04	₹ 72
6 Module GI Box NDN 0.8 mm	20 N	(20.98x7.6) cm / (8 x 3)	ASIXMIAX06	₹ 113
1/2 Module GI Box	60 N	(7.6x7.6) cm / (3 x 3)	ASIXMIIX01	₹ 58
3 Module GI Box	40 N	(10.58x7.6) cm / (4 x 3)	ASIXMIIX03	₹ 71
4 Module GI Box	30 N	(13.56x7.6) cm / (5 x 3)	ASIXMIIX04	₹ 83
6 Module GI Box	20 N	(20.98x7.6) cm / (8 x 3)	ASIXMIIX06	₹ 129
8 Module GI Box	20 N	(13.56x13.6) cm / (5 x 5)	ASIXMIIX08	₹ 157
8 (H) Module GI Box	20 N	(22.7x7.6) cm / (9 x 3)	ASIXMIIH08	₹ 157
8 Module GI Box (H) with 6 clamp	20 N	(22.7x7.6) cm / (9 x 3)	ASIXMIIH08	₹ 161
9 Module GI Box	20 N	(25.4x7.6) cm / (10 x 3)	ASIXMIIX09	₹ 165
12 Module GI Box	10 N	(20.98x13.6) cm / (8 x 6)	ASIXMIIX12	₹ 184
16 Module GI Box	10 N	(23x14.1) cm / (9 x 5.5)	ASIXMIIX16	₹ 220
18 Module GI Box	5 N	(20.98x21) cm / (9 x 8)	ASIXMIIX18	₹ 247

Item Name	Std./Master Packing (No. of Unit/s)	Size (cm) / inch	SAP Code	List Price in ₹ Per Unit
1/2 Module SM Box	10 N / 140 N	(7.6x7.6) cm / (3 x 3)	ASIXMIZX01	₹ 83.00
3 Module SM Box	10 N / 100 N	(10.58x7.6) cm / (4 x 3)	ASIXMIZX03	₹ 99.00
4 Module SM Box	10 N / 90 N	(13.56x7.6) cm / (5 x 3)	ASIXMIZX04	₹ 112.00
6 Module SM Box	10 N / 60 N	(20.98x7.6) cm / (8 x 3)	ASIXMIZX06	₹ 147.00
8 (V) Module SM Box	5 N / 55 N	(13.56x13.6) cm / (5 x 5)	ASIXMIZV08	₹ 162.00
8 (H) Module SM Box	5 N / 55 N	(22.7x7.6) cm / (9 x 3)	ASIXMIZH08	₹ 162.00
12 Module SM Box	5 N / 35 N	(20.98x13.6) cm / (8 x 6)	ASIXMIZX12	₹ 225.00

PRODUCT FEATURES

What makes Standard switches the best is advance technology blended with excellence. switches, sockets and accessories are designed for the rugged Indian conditions. The range created from self extinguishing polycarbonate plastic, can withstand the glow wire test at 850 °C, also ultra-violet stabilized material is used to avoid discoloration even after long exposure to sunlight.

SWITCH

- Fully conforms to IS-3854-2023.
- UV light stabilised, unbreakable engineering plastic housing.
- Silver cadmium oxide (AgCdO) contacts provide high conductivity and anti-weld properties.
- Dome shaped moving contact and flat head fixed to provide positive contact.
- Special steel springs to provide consistent contact pressure.
- Rocker profile provides lever effect to increase contact pressure and minimise temperature rise.
- Silver plated brass terminals to provide high conductivity and reduce heating.
- Liberal terminal hole size provided to accept wires upto 6 mm².
- Inhouse NABL accredited Switches.
- CE certified switches for current ratings of 10 AX, 10 A Bell Push, 16 AX, 25 A, 32 A.

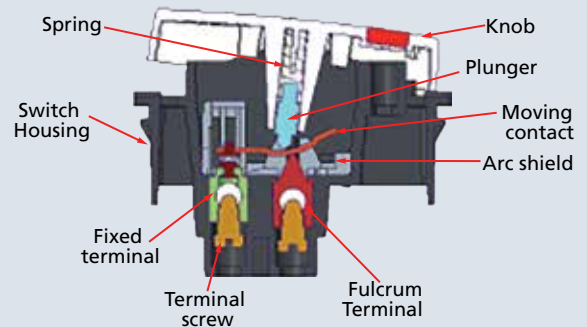
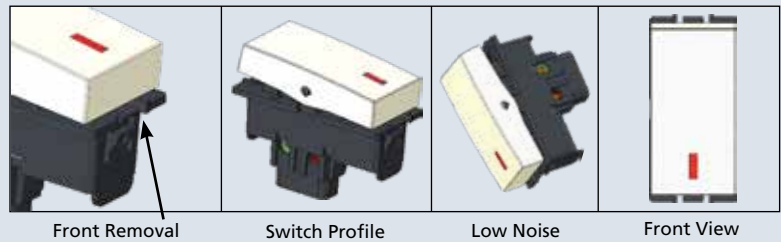

DETAILS OF INTERIORS OF A SWITCH

Standard switches, manufactured in accordance with IS-3854-2023 specifications have various in-built beneficial features. The integral design of terminals and contacts make the switch capable of withstanding high overload conditions. There is sufficient clearance between the moving contact and fixed contact to break the arc, during operation of the switch.

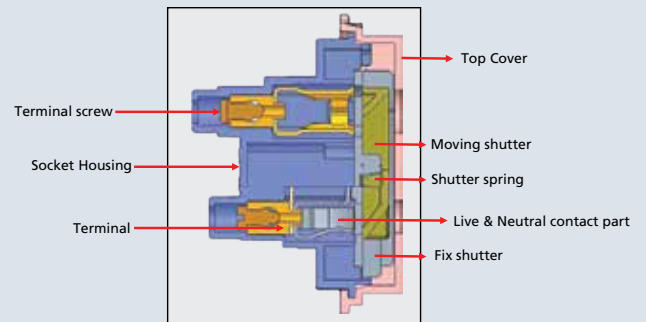

SOCKET

- Fully conforms to IS-1293-2019.
- UV stabilized, unbreakable polycarbonate casing.
- Inhouse NABL accredited Sockets.
- Connector of brass to provide high conductivity, flexibility and contact pressure.
- Silver plated brass terminals to reduce heating and improve conductivity.



DETAILS OF INTERIORS OF A SOCKET

Sockets come with brass connectors for better connectivity and durability besides retaining its shape even after 10,000 strokes (plugging in and out the 3 pin plugs). All sockets and plugs fully comply with IS-1293-2019 specifications.

5 STEP FAN REGULATORS

- Highly efficient and energy conservative (no power loss).
- No radio waves interference.
- Low noise levels.
- Step control.
- Modular construction (can be easily clipping on to modular plates without screws).
- Highly reliable (tested for 5000 electrical operating cycles).
- UV stabilised housing.
- Soft operation.
- High insulation resistance greater than 2 MΩ. Use of reputed make of components.
- Inhouse NABL accredited fan regulators.
- Equipped with Safety Film Capacitors.



Havells India Ltd. ("Company") hereby warrants these products, against manufacturing defects, commencing from the date of purchase invoice for the period as specified in the table below :-

S. No.	Product	Warranty Period
1	Mechanical Modules - Switches, all type of sockets in white & PC White Cover plates.	10 Year
2	Electronic Modules -Fan regulator, Dimmer, Telephone sockets, Computer sockets, USB Chargers, Data Socket (HDMI,VGA, HD15, USB Data) & Indicator switches, Mechanical Modules-Switches & all types of Sockets in painted colors.	1 Year
3	Decorative plates (Glass, Metal and Wood), Painted Cover plates, PC plates with Chrome / Color finish & all modular SKUs with colour painted.	1 Year
4	* Extension Board (Powerstrip, Spikeguard, Flexbox), Door bell, Water bell, Adaptor.	6 months (No Home service)

Warranty Terms and Conditions for products mentioned from S. No. 1 to 3

- To avail Warranty services, customer can log in his requests with the customer care cell and must present original invoice and wherever possible original Warranty Certificate (duly signed and stamped by the Selling Dealer) to the Authorised Service Representative.
- Company will repair or replace the product at its discretion, if any manufacturing defect is found in the product.
- Warranty of repaired or replaced product shall thereafter continue only for unexpired period of Warranty and defective product shall be property of Company or its Authorized Service Partner during Warranty period.
- Company will not be liable for any delay or failure in performance resulting from causes beyond its control including non-availability of any part, labour problem, restrictions and regulations of the government, public movement, war and any other unavoidable/unforeseen circumstances including any force majeure event, specially vis-à-vis the import of supplies and raw material.
- It is clarified that the Company will not be responsible to the customer for any economic loss, commercial loss, consequential or resulting liability, damage to the property or any other harm or loss.
- In the event of any unforeseeable circumstance same product or product with similar design is not available, product will be replaced with an equivalent model available at that time.

Warranty excludes or does not apply:

- If the product is serviced or repaired by any person other than the Authorized Service Representative of the Company.
- If customer violates Warranty Terms and Conditions, instruction and installation guidelines, recommendations of Authorised Service Representative and/or operates the product otherwise than as per product specifications.
- If the serial number affixed on the product is damaged, erased or tampered with or if product is refurbished/modified.
- If the product is operated in conditions otherwise than normal conditions (e.g., abnormal voltage surge, extreme environmental conditions etc.).
- Any harm caused due to accident, negligence, improper maintenance, mishandling, tampering, incurred in transit by the customer or which can be attributed to the fault of the customer.
- Any harm resulting from any unforeseeable circumstances such as force majeure event etc.
- Any harm caused due to any defect in any electrical/civil installation(s), wiring or third party products.
- If Company's mounting boxes have not been used to mount the plates and accessories.

***For Warranty Terms and Conditions of Extension Board, Doorbell, Water Bell, and Adaptor, please visit our website www.standardelectricals.com**

Terms & Conditions :

- Prices are in Indian ₹.
- The List prices are inclusive of GST.
- This Price List supersedes all our previous Price Lists.
- Prices are subject to change without notice.
- Company reserves the right to issue amendments, which may arise due to any errors in the price list.
- All list prices mentioned above are for quantity 1 N.

Product Category	HSN CODE
Switch, Socket, Motor Starter, Fuse, TV Socket, MCB, ACCL, RCBO, RCCB	8536
RJ-11, RJ-45, Mini MCB, MMR, DND	8536
Ket tag, VGA, HDMI, USB Data port	8536
Plates, Boxes	8538
Fan Regulator, Dimmer	8414
Night Lamp, Buzzer, electronic Chime, PIR Sensor	8531
USB Charger	8504
Foot light	9405
Distribution Board	8537
Time Switch	9107



S STANDARD

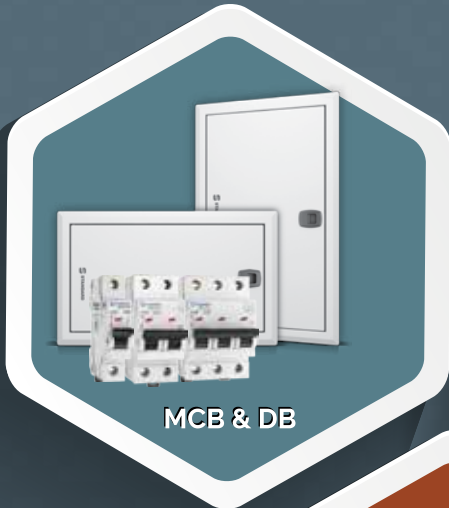

MCB & DB

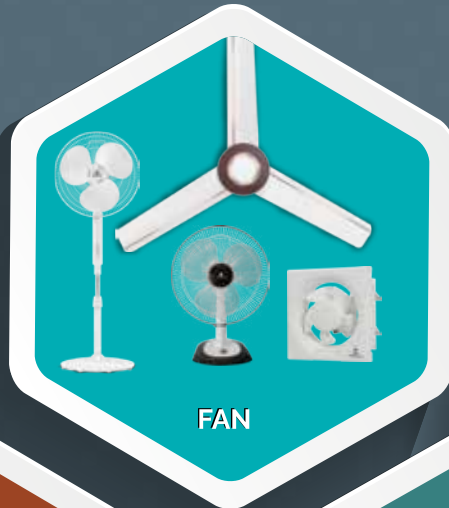

FAN



WIRE & CABLE

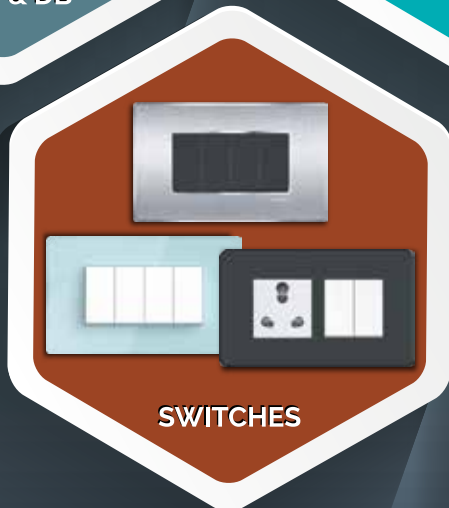

SWITCHES



WATER HEATER

Actual products may vary in colour, design, description and colour combination etc. Although every effort has been made to ensure accuracy in the compilation of the technical detail within this publication. Specifications & performance data are constantly changing.

Havells India Ltd.

Corp Office: QRG Towers, 2D, Sector-126, Expressway, Noida-201304 (U.P). (India)
Ph. +91-120-3331000, E-mail: standard.ho@havells.com, www.standardelectricals.com
Customer Care No. 08045 77 1313, CIN - L31900DL1983PLC016304.



Scan to
Know More